

MINIATURE COAXIAL CONNECTORS

# BNC series



ISO 9001 APPROVED



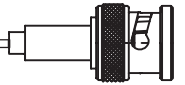

	Page
RADIALL company profile .....	4-5
Introduction .....	6
General .....	7
Finder guide .....	8-9
<b>Commercial BNC</b>	
Plugs .....	10
Jacks .....	10
Bulkhead receptacles .....	11
PCB receptacles .....	11
<b>BNC 50Ω</b>	
Interface .....	14
Characteristics .....	15-16
Straight plugs .....	17
Right-angle plugs .....	18
Straight jacks .....	19
Flange mount, jacks .....	20
Bulkhead mount, jacks .....	21
Flange mount, receptacles .....	22
Bulkhead mount, receptacles .....	23
Press mount, receptacles .....	24
Male receptacles .....	24
PCB receptacles .....	25
In series adapters .....	26
Caps .....	27
<b>BNC 75Ω</b>	
Characteristics .....	28
Straight plugs .....	29
Right-angle plugs .....	30
Straight jacks .....	31
Flange mount, jacks .....	31
Bulkhead mount, jacks .....	32
Flange receptacles .....	33
Bulkhead receptacles .....	33
Male receptacles .....	33
PCB receptacles .....	34
In series adapters .....	34-35
<b>ADDITIONAL CONNECTORS</b>	
Connectors with flat gasket .....	36
50Ω connectors for 75Ω or 93Ω cable .....	36
75Ω connectors for 93Ω cable .....	37
Connectors for BT or special cables .....	37
Connectors with special finish .....	37
ACCESSORIES .....	38-39
BETWEEN SERIES ADAPTERS .....	40
<b>MICROWAVE COMPONENTS</b>	
Finder guide .....	41
Resistive pads .....	42
Terminations .....	42-43
Attenuators .....	43-44
<b>TOOLING</b>	
Tools for semi-rigid cables .....	45-46
Tools for flexible cables .....	47
PANEL CUT OUT .....	50-51
ASSEMBLY INSTRUCTIONS .....	52-66
DIMENSIONS OF CABLES .....	67
INDEX OF RADIALL PART NUMBERS with description .....	68-73

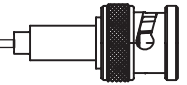

The BNC connector, the most popular coaxial connector series in the world, features a two-pin bayonet coupling system for quick and reliable engagement and disengagement.

● **Wide range :**

RADIALL's BNC connectors are available with two characteristic impedances 50Ω and 75Ω; and, they are completely intermateable with one another.

The BNC range offers cable connectors for both flexible or semi-rigid cables, panel and PCB mount receptacles including press mount, through hole and press fit pins connectors. In series adapters and between series adapters including PUSH-ON type are also available.

RADIALL offers you also a low cost range called commercial BNC, whose characteristics are compared to those of the standard BNC in the chart here under.

● **Convenient 3-piece design :**

A range of crimp type cable connectors (straight and right angle models) features :

a 3 piece design : single piece body + center contact + outer ferrule,

You can find them with the "single piece body" mention on note.

● **Fast and reliable cable attachment :**

The cable connectors can be either fully crimped or soldered/crimped, offering full flexibility for high volume production with standard manual or pneumatic tooling : fast and reliable.

- ☞ the center contact can be either crimped or soldered,
- ☞ the outer contact is attached to the cable by crimping a ferrule.

	Standard BNC		Commercial BNC	
Applications	Military Telecommunications Civil telecommunications Measurement and instrumentation General electronics		Civil Telecommunications Datacommunications Measurement and instrumentation Broadcast application Security & video systems Antennas Automotive industry General electronics	
Impedance	50 Ω	75 Ω	50 Ω	75 Ω
Codification	R141 XXX XXX	R142 XXX XXX	R141 XXX 161	R142 XXX 161
Frequency range	DC - 4 GHz	DC - 1 GHz	DC - 1.5 GHz	
Temperature range	- 65°C / + 165°C		-35°C / + 70°C	
Durability	500 matings		100 matings	
Coupling nut	Cross knurl		Straight knurl	
Material <i>Coupling nut</i> <i>Insulator</i> <i>Female center contact</i>	Brass PTFE Beryllium copper		Die cast zinc Polypropylen Brass	

Radiall also offers a complete range of MICROWAVE COMPONENTS : terminations, attenuators, etc. designed around the BNC interface (page 41-44).

For further details, please ask for our :

- ☞ PUSH-ON adapters **D1 036 DE**
- ☞ Between series adapters **D1 191 CE**
- ☞ Attenuators **D3 200 CE**
- ☞ Terminations **D3 100 CE**
- ☞ Soldering device **D1 035 DE**

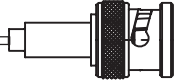

<b>50 <math>\Omega</math></b>	<b>DC - 4 GHz</b> <b>DC - 1.5 GHz (Commercial)</b>
<b>75 <math>\Omega</math></b>	<b>DC - 1 GHz</b> <b>DC - 1.5 GHz (Commercial)</b>

### GENERAL

- Worldwide standardised coaxial connectors
- Bayonet coupling
- Proven strength and reliability
- Good RF performance
- 2 ranges : **BNC 50  $\Omega$**   
**BNC 75  $\Omega$**
- Commercial BNC
- Safety BNC (please consult RADIALL)

### APPLICABLE STANDARDS

- MIL-C-39012 / MIL STD 348-A/301
- IEC 169-8
- CECC 22120
- NF-C-93564 KBN series
- UTE-C-93564

### APPLICATIONS

- Civil and military radio-telecommunication equipment
- Test and measurement
- Videocommunication
- Computer network
- Industrial network
- General electronics

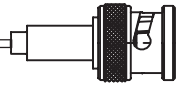

## CABLE CONNECTORS



Model cable	Straight plug		Right-angle plug		Straight jack		Square flange straight jack		Bulkhead straight jack	
	crimp and full crimp	clamp	crimp and full crimp	clamp	crimp and full crimp	clamp	crimp and full crimp	clamp	crimp and full crimp	clamp
2/50/S (RG 178)		R141 003 000 (page 17)		R141 153 000 (page 18)			R141 285 000 (page 20)	R141 253 000 (page 20)	R141 301 000 R141 303 503 (page 21)	R141 323 000 (page 21)
2.6/50/S (RG 316)	R141 075 000 (page 17) R141 075 161 (page 10)	R141 004 000 (page 17)	R141 181 161 (page 10)	R141 154 000 (page 18)	R141 217 000 (page 19)		R141 290 200 (page 20)	R141 254 000 R141 277 000 R141 278 000 (page 20)	R141 306 000 R141 306 503 R141 331 400 R141 331 500 (page 21)	R141 304 000 R141 324 000 (page 21)
2.6/50/D (RD 316)		R141 004 000 (page 17)		R141 154 000 (page 18)				R141 254 000 R141 277 000 R141 278 000 (page 20)		R141 304 000 R141 324 000 (page 21)
2.6/75/S	R142 076 000 (page 29) R142 076 161 (page 10)	R142 004 000 (page 29)		R142 154 000 (page 30)	R142 217 000 (page 31)			R142 202 000 (page 31)	R142 306 500 R142 306 503 R142 306 520 R142 331 011 (page 32)	
3.8/93/S	R142 078 161 (page 10)									
5/50/S (RG 58)	R141 072 000 R141 082 000 (page 11) R141 082 161 (page 10)	R141 007 161 (page 10) R141 009 000 R141 010 000 (page 17)	R141 182 000 (page 18) R141 182 161 (page 10)	R141 156 000 (page 18)	R141 237 000 (page 19) R141 237 161 (page 10)	R141 207 000 R141 208 000 (page 19)	R141 292 000 (page 20)	R141 256 000 R141 258 000 R141 259 000 (page 20)	R141 308 000 R141 332 500 (page 21) R141 332 161 (page 10)	R141 327 000 (page 21)
5/50/D (RG 142)	R141 083 000 (page 17)	R141 007 161 R141 009 000 R141 010 000 (page 17)	R141 183 000 (page 18)	R141 156 000 (page 18)	R141 220 000 (page 19)	R141 207 000 R141 208 000 (page 19)	R141 297 000 (page 20)	R141 256 000 R141 258 000 R141 259 000 (page 20)		R141 327 000 (page 21)
5/75/D	R142 083 000 (page 29)									
6/75/S (RG 59)	R142 085 000 (page 29) R142 085 161 (page 10)	R142 016 000 (page 29) R142 016 161 (page 10)	R142 184 000 (page 30) R142 184 161 (page 10)	R142 157 000 (page 30)	R142 242 000 (page 31) R142 242 161 (page 10)		R142 295 000 (page 31) R142 295 161 (page 10)	R142 268 000 (page 31)	R142 334 161 (page 10)	R142 329 000 (page 32)
8/75/S		R142 017 000 (page 29)								
10 + 11/50		R141 018 000 (page 17)								
10 + 11/75	R142 095 000 (page 29)	R142 018 000 (page 29)								
.141" (RG 402)		R141 052 000 (page 17)				R141 227 000 (page 19)				R141 338 000 (page 21)

## CAPS

Model	Free	Cord	Chain	short- circuit chain
M	R141 802 000 (page 27)	R141 812 000 R141 812 010 (page 27)		R141 862 000 (page 27)
F			R141 842 000 (page 27)	

**ATTENTION !** This guide is intended as an information and does not include all BNC SERIES P/N.

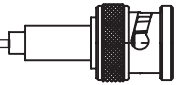

RECEPTACLES		R141 xxx 161 BNC 50 Ω commercial				R142 xxx 161 BNC 75 Ω commercial				PCB receptacles		
		Straight female flange		Right-angle female flange	Straight female bulkhead		Straight male flange	Straight male bulkhead	Press mount receptacle	straight	right angle	bulkhead right angle
Model cable	square	2 hole	square	front mount	right angle	square	front mount	straight				
Solder contact with solder pot	R141 403 000 R141 403 500 R141 404 000 R141 406 000 R141 407 000 R142 407 000 R142 412 000 (page 33)	R141 453 000 (page 22)	R141 653 000 R141 654 000 (page 22)	R141 554 000 R141 557 000 R141 559 000 R141 572 000 R141 574 000 R141 6xx 000 (page 23) R142 562 000 R142 562 290 (page 33) R141 563 161 R141 554 161 R141 574 161 R141 576 161 (page 11)	R141 680 000 (page 23)	R141 440 000 (page 24)	R141 580 000 (page 24) R142 580 000 (page 33)	R141 501 120 (page 24)				
Solder cylindrical contact								R141 500 200 (page 24)				
Solder pins (standard space)									R141 426 000 R141 426 165 (page 25) R142 426 000 R142 426 030 (page 34) R141 426 161 R142 426 161 (page 11)	R141 665 000 R141 665 030 (page 25) R141 665 161 (page 11)	R141 676 121 R141 676 423 R141 676 433 (page 25)	
Solder pins (reduced space)									R141 508 200 (page 25)			
Press fit pins									R141 416 000 (page 25)		R141 684 130 (page 25)	

## IN-SERIES ADAPTERS

Model	Straight	Straight bulkhead	Straight flange	Right-angle	Tee	Cross
M - M	R141 703 000 (page 26) R142 703 000 (page 34)					
F - F	R141 704 000 (page 26) R142 704 000 (page 34)	R141 720 000 R141 723 000 R141 730 000 R141 753 000 (page 26) R142 720 000 R142 723 000 (page 34) R141 720 161 R141 723 161 R142 720 161 (page 11)	R141 710 000 R141 717 000 (page 26) R142 710 000 (page 34)			
M - F				R141 770 000 (page 26) R142 770 000 (page 34)		
F - F / M					R141 780 000 R141 789 000 (page 26) R142 780 000 R142 789 000 (page 35)	
F - F / F					R141 782 000 (page 26) R142 782 000 (page 35)	
M - F - F / F						R141 799 000 (page 26)

**ATTENTION !** This guide is intended as an information and does not include all BNC SERIES P/N.



# Commercial BNC

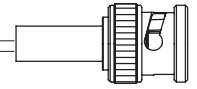

Excellent QUALITY / price ratio, for video communication, data communication, instrumentation, telecommunication, portable radio systems, security systems, antenna systems, automotive industry and broadcast application... Commercial BNC connectors are intermateable with all 50 and 75Ω BNC connectors.

## ELECTRICAL CHARACTERISTICS

Impedance	50 Ω and 75 Ω
Operating frequency	DC to 1.5 GHz
V.S.W.R. typical (1.5 GHz)	
<i>Straight models</i>	
∅ 2.6	1.21
∅ 5	1.14
∅ 6	1.05
<i>Right angle models</i>	
∅ 5 & ∅ 6	1.17
Testing voltage (V.R.M.S)	1500
Operating voltage (V R.M.S)	500
Insulation resistance (MΩ)	5000
Contact resistance (mΩ)	10

## MECHANICAL CHARACTERISTICS

Durability	100 mating
------------	------------

## MATERIALS

Male and female bodies	Brass
Coupling nut	Die cast zinc
Outer contact	Brass
Insulators	Polypropylene
Male and female center contacts	Brass

## PLATING

Bodies	Nickel
Center contact	Gold

## ENVIRONMENTAL CHARACTERISTICS

Temperature range	-35°C + 70°C
-------------------	--------------

Standard packaging : 100 unit box. Unit packaging : add W after the P/N. Ex. : **R141 007 161W**.

## PLUGS, CRIMP & CLAMP TYPE FOR FLEXIBLE CABLES

Straight plug clamp type			Straight plug crimp type				Right angle plug crimp type		
Cable	Part number	Imp.	Cable	Part number	Imp.	dim.A	Cable	Part number	Imp.
5 /50/ S+D	<b>R141 007 161</b>	50	2.6 /50/ S	<b>R141 075 161</b>	50	30	2.6 /50/ S	<b>R141 181 161</b>	50
6 /75/ S	<b>R142 016 161</b>	75	5 /50/ S	<b>R141 082 161</b>	50	28	5 /50/ S	<b>R141 182 161</b>	50
			2.6 /75/ S	<b>R142 076 161</b>	75	31	6 /75/ S	<b>R142 184 161</b>	75
			3.8 /93/ S	<b>R142 078 161</b>	75	30			
			6 /75/ S	<b>R142 085 161</b>	75	28			

## JACKS, FULL CRIMP TYPE FOR FLEXIBLE CABLES

Straight jack			Square flange jack			Bulkhead jack		
Cable	Part number	Imp.	Cable	Part number	Imp.	Cable	Part number	Imp.
5 /50/ S	<b>R141 237 161</b>	50	6 /75/ S	<b>R142 295 161</b>	75	5 /50/ S	<b>R141 332 161</b>	50
6 /75/ S	<b>R142 242 161</b>	75				6 /75/ S	<b>R142 334 161</b>	75

All dimensions are given in mm.

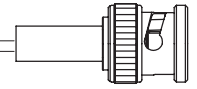

## RECEPTACLES AND ADAPTERS

Straight bulkhead female receptacle		Straight insulated bulkhead female receptacle	
Part number	imp.	Part number	imp.
<b>R141 554 161</b>	50	<b>R141 574 161</b>	50
<b>R141 563 161</b>	50		

Straight screw-on female receptacle		Straight female/female bulkhead adapter	
Part number	imp.	Part number	imp.
<b>R141 561 161</b> ●	50	<b>R141 720 161</b> (die cast zinc)	50
		<b>R141 723 161</b> (insulated)	50
		<b>R142 720 161</b> (die cast zinc)	75

● Upon request

## PCB RECEPTACLES, THROUGH HOLE SOLDER TYPE

Straight female		Right angle female	
Part number	imp.	Part number	imp.
<b>R141 426 161</b>	50	<b>R141 665 161</b> (die cast zinc)	50
<b>R142 426 261</b>	75		



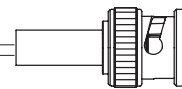

### CABLE STRIPPER



For flexible cable	Part number	Replacement blades
RG58 RG59 RG62	<b>R299 510 000</b>	<b>R299 511 001</b>

### CRIMPING TOOL





Cable	Part number	Hex. mm (inch)
RG58C/U RG59B/U RG62B/U RG174A/U RG179B/U	<b>R282 223 000</b>	1.73 (.068) 5.41 (.213) 6.48 (.255)

### MIL CRIMP TOOL (M22520/5-01) R282 293 000 (DIES NOT INCLUDED)



### DIES

Part number	Cable group		
<b>R282 235 003</b>	2.6 /50/ S	3.25 (.128)	2.67 (.105)
<b>R282 235 011</b>	5 /50/ S - 5 /50/ D	5.41 (.213)	1.73 (.068)
<b>R282 235 013</b>	6 /75/ S	6.48 (.255)	1.73 (.068)

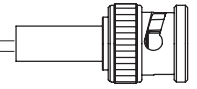

### SOLDER TAG

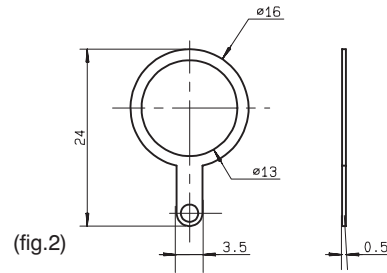
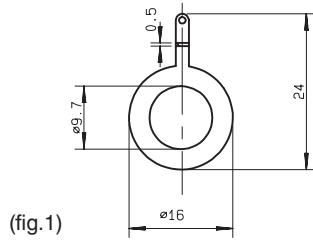

Part number	to be used on	Finish	Packaging
R280 490 020 (fig.1)	R141 563 161	Nickel	100 units
R280 490 030 (fig.2)	R141 332 161 R142 334 161		

### INSULATING WASHERS

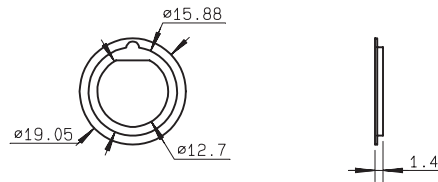

Part number	to be used on	material	Packaging
R280 907 000	R141 332 161 R142 334 161	Nylon	100 sets (200 washers)

### BOOTS (PVC)

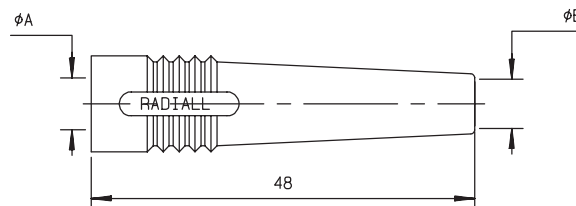

Cables	Part number (1 boot)	Color	dimensions		Packaging
			A	B	
RG179B/U RG187B/U	R280 566 000	Black	5.5	2.6	10
RG58C/U	R280 570 000	Black	5.5	5.1	100
	R280 571 000	Red			10
	R280 572 000	Green			10
	R280 573 000	Blue			10
	R280 574 000	Yellow			10
RG59B/U RG62B/U	R280 590 000	Black	6.5	6	10
	R280 591 000	Red			10
	R280 592 000	Green			10
	R280 593 000	Blue			10
	R280 594 000	Yellow			10

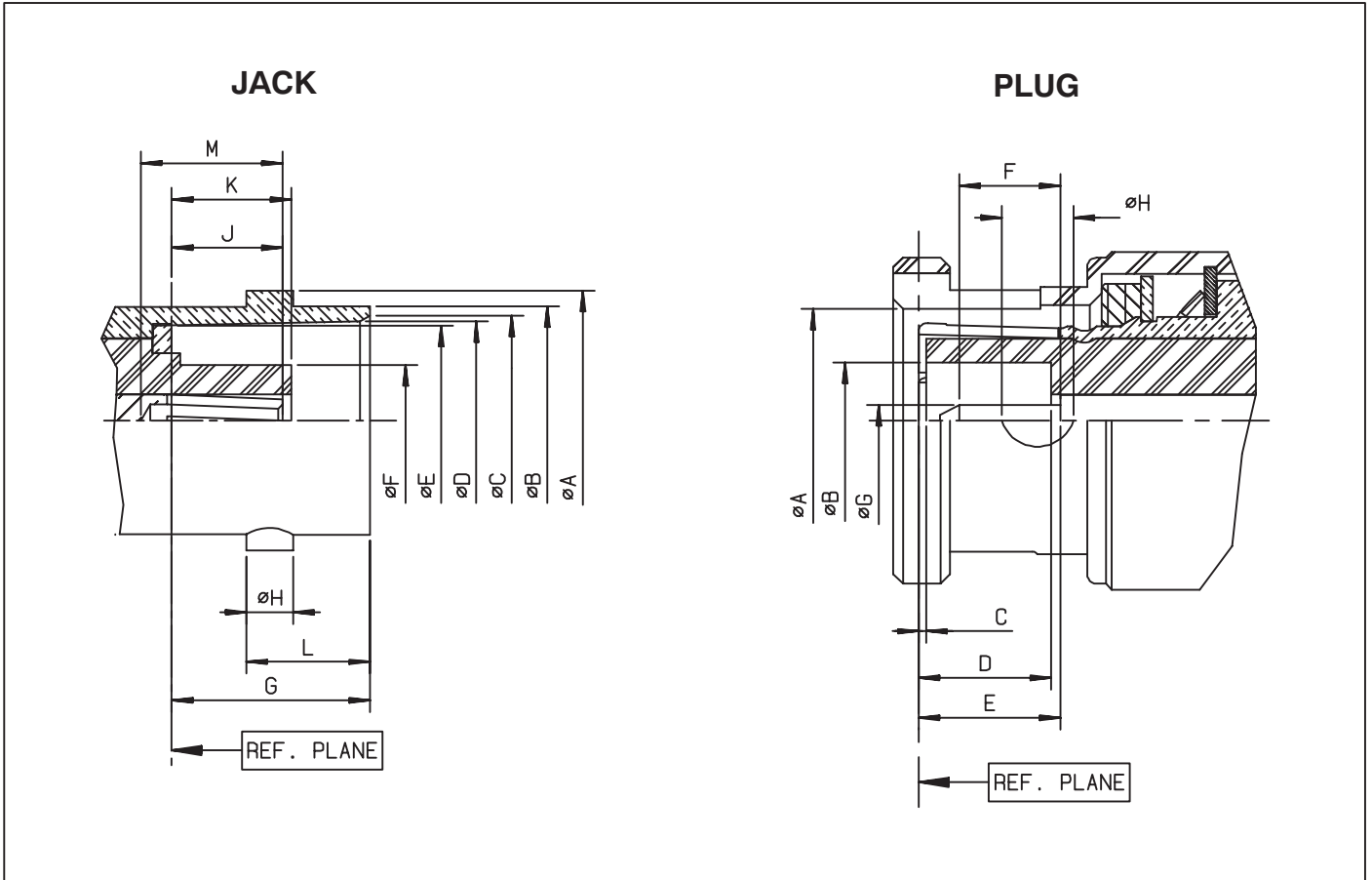
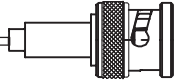

JACK

LETTER	mm		inch	
	min.	max.	min.	max.
A DIA	10.97	11.07	.432	.436
B DIA	9.60	9.70	.378	.382
C DIA	8.79	9.04	.346	.356
D DIA	8.31	8.46	.327	.333
E DIA	8.10	8.15	.319	.321
F DIA	-	4.72	-	.186
G	8.31	8.51	.327	.335
H	1.91	2.06	.075	.081
J	4.72	5.23	.186	.206
K	4.78	5.28	.188	.208
L	5.18	5.28	.204	.208
M	4.95	-	.195	-

PLUG

LETTER	mm		inch	
	min.	max.	min.	max.
A DIA	9.78	9.91	.385	.390
B DIA	4.83	-	.190	-
C	0.15	-	.006	-
D	5.28	5.79	.208	.228
E	5.33	5.84	.210	.230
F	1.98	-	.078	-
G DIA	1.32	1.37	.052	.054
H DIA	2.31	2.46	.091	.097

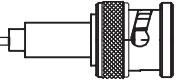

TEST/CHARACTERISTICS	STANDARD REFERENCE	VALUES/REMARKS		
----------------------	--------------------	----------------	--	--

### ELECTRICAL CHARACTERISTICS

Impedance		50 Ω		
Frequency range		DC-4 GHz		
Typical V.S.W.R. <i>Straight models cable group : 2/50, 2.6/50, 5/50, 10 + 11/50, .141"</i> <i>Right angle models 2/50, 2.6/50, 5/50,</i>		1 GHz 1.12	2.5 GHz 1.18 1.30 max	4 GHz 1.22
Insertion loss <i>straight connector</i> <i>right-angle connector</i>		0.05 0.08	0.07 0.16	0.13 0.20
RF Leakage		- 55 dB min from 2 to 3 GHz		
Insulation resistance		5000 MΩ min	5000 MΩ min	5000 MΩ min
Contact resistance <i>center contact</i> <i>outer contact</i>	MIL	1.5 mΩ 0.2 mΩ		
Working voltage in VRMS <i>at sea level</i> <i>(at 21 000m)</i>		500 125		
Dielectric withstanding voltage in VRMS <i>at sea level</i> <i>(at 21 000m)</i>		1500 375		
RF testing voltage in VRMS <i>sea level (5 MHz)</i>		1000		

### MECHANICAL CHARACTERISTICS

Durability		500 matings		
Force to engage and disengage <i>axial torque</i>		13.6 N max 28.6 Ncm		
Coupling nut retention force	MIL	445 N		
Cable retention force <i>cable 2/50, 2.6/50</i> <i>cable 5/50, 10 + 11/50</i> <i>cable .141"</i>		227 N		
Center contact retention force		27.2 N		

### ENVIRONMENTAL CHARACTERISTICS

Temperature range <i>flexible cables</i> <i>semi-rigid cables</i>	MIL	- 65°C + 165°C - 65°C + 105°C		
Thermo cycling test		MIL STD 202, method 107, condition B		
Thermal shock		MIL STD 202, method 107, condition B		
Hight temperature endurance		MIL STD 202, method 108		
Corrosion salt spray		MIL STD 202, method 101, condition B		
Vibration		MIL STD 202, method 204, condition B		
Shock		MIL STD 202, method 213, condition G		
Moisture resistance		MIL STD 202, method 106		
Hermetic test		MIL STD 202, method 112, condition C vacuum 10 <sup>-6</sup> Hgmm (Torr) leakage rate < 10 <sup>-6</sup> atm/cm <sup>3</sup> /s		
Barometric pressure		Pressure test : 3.5 bars; duration : 2 mn; temperature : 15° C to 25 °C		

# BNC 50 Ω

## CHARACTERISTICS

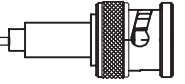

### MATERIALS

Bodies		Brass
Center contact	<i>male</i> <i>female</i>	Brass Bronze or heat treated beryllium following QQ-C-530
Nut		Brass
Insulator		PTFE
Gasket		Silicon rubber

### PLATINGS

Bodies		Nickel
Center contacts		Gold

### POWER RATING

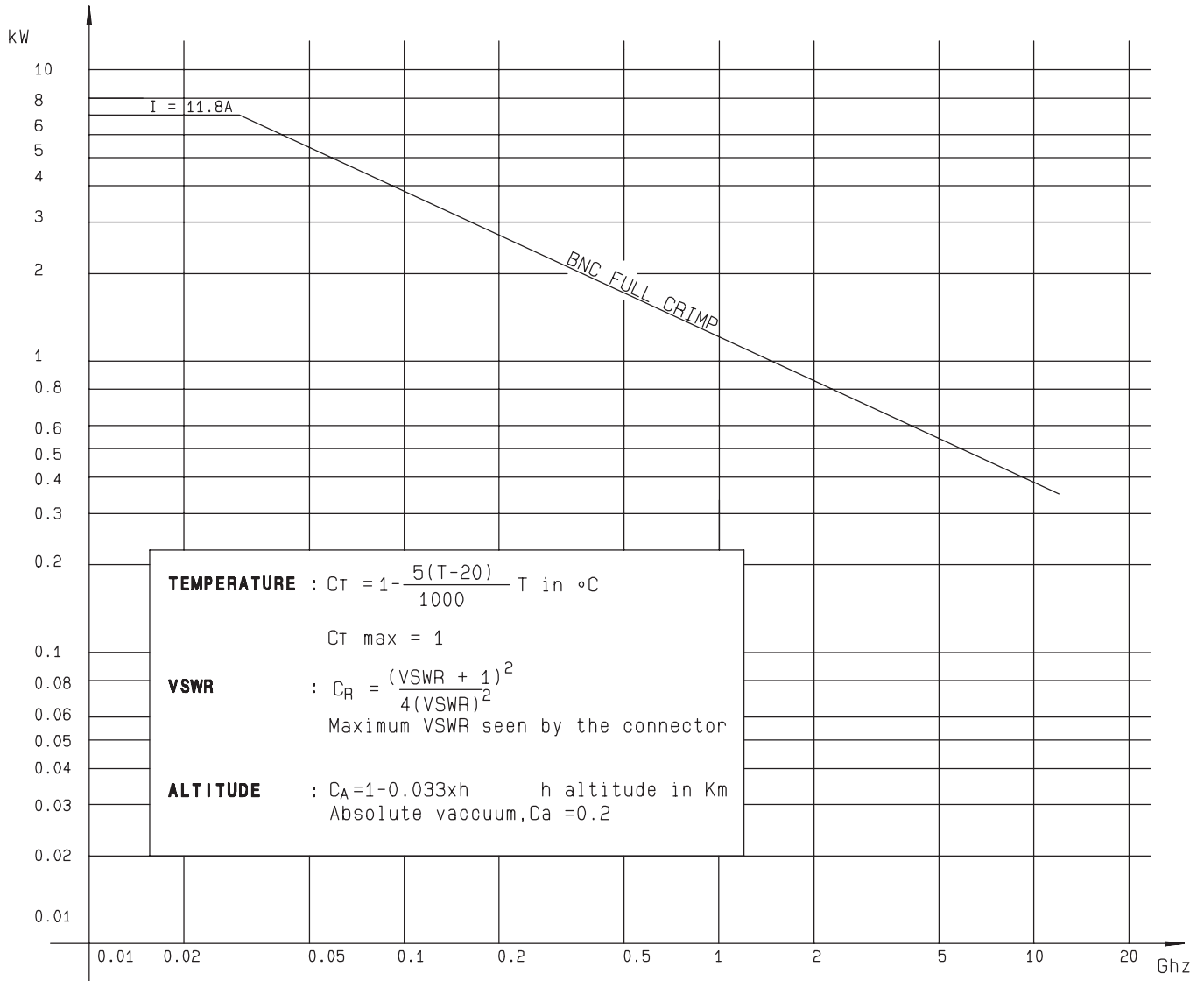

Standard packaging : unit

All dimensions are given in mm.

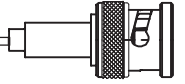

### STRAIGHT PLUGS CLAMP TYPE

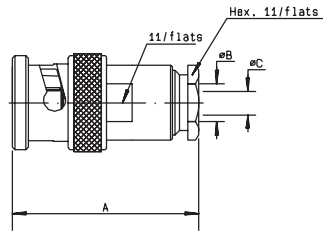

Fig. 1

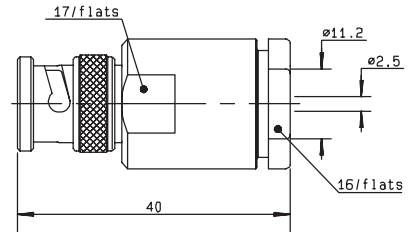

Fig. 2

cable	part number	fig.	dimensions			captive center contact	assembly	note
			A	B	C			
2 /50/ S + D	R141 003 000	1	27	2.2	0.6	yes	M02	
2.6 /50 S + D	R141 004 000*	1	27	3.1	0.6	yes	M02	
5 /50/ S + D	R141 009 000*	1	28	5.6	1.2	no	M01	
5 /50/ S + D	R141 010 000	1	28	5.6	1.05	yes	M01	
10 +11 /50 S +D	R141 018 000*	2				yes	M01	
.141"	R141 052 000	1	29	3.65	1.2	no	M10	semi-rigid cable

### STRAIGHT PLUGS FULL CRIMP TYPE FOR FLEXIBLE CABLES

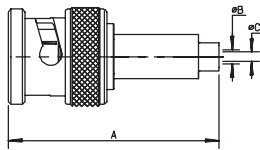

Fig. 1

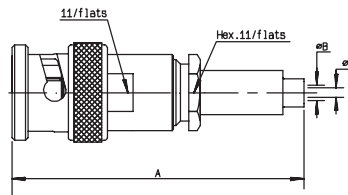

Fig. 2

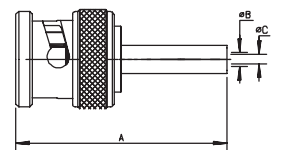
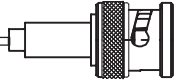

Fig. 3

cable	part number	fig.	dimensions			captive center contact	assembly	note
			A	B	C			
2.6 /50/ S	R141 075 000*	1	31	1.8	0.6	yes	M05	
5 /50/ S	R141 072 000	2	39	3.1	1.05	yes	M09	
5 /50/ S	R141 082 000*	3	28	3.1	1.05	yes	M07	single piece body
5 /50/ D	R141 083 000*	3	28	3	1.05	yes	M07	single piece body

For others types of cables (75Ω, 93Ω or BT cables), please see "additional connectors" on page 36-37.

\* Packaging = 100 pieces.



### RIGHT ANGLE PLUGS CLAMP TYPE FOR FLEXIBLE CABLES

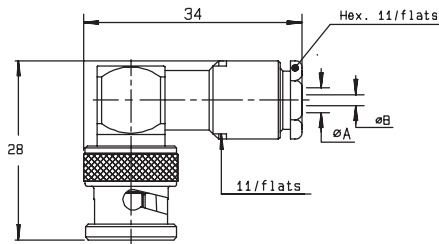

Fig. 1

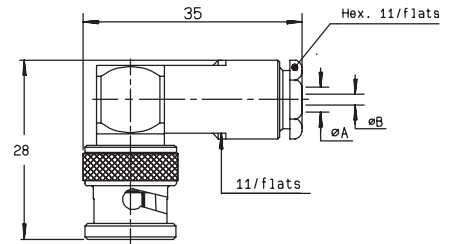
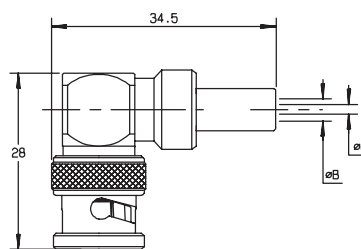

Fig. 2

cable	part number	fig.	dimensions		captive center contact	assembly
			A	B		
2 / 50/ S + D	R141 153 000	1	2.2	0.6	yes	M02
2.6 / 50/ S + D	R141 154 000	1	3.1	0.6	yes	M02
5 / 50/ S + D	R141 156 000	2	5.6	1.05	yes	M01

### RIGHT ANGLE PLUGS FULL CRIMP TYPE FOR FLEXIBLE CABLES



cable	part number	dimensions		captive center contact	assembly	note
		B	C			
5 / 50/ S	R141 182 000*	5.5	1.05	yes	M07	single piece body
5 / 50/ D	R141 183 000	5.8	1.05	yes	M07	single piece body

For others types of cables (75Ω, 93Ω or BT cables), please see "additional connectors" on page 36-37.

\* Packaging = 100 pieces.



# BNC 50 Ω

## STRAIGHT JACKS

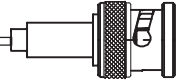

### STRAIGHT JACKS CLAMP TYPE

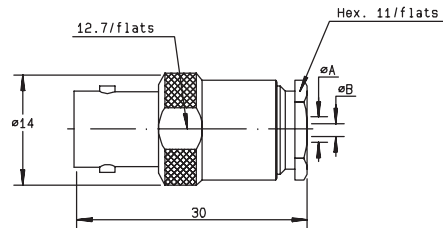

cable	part number	dimensions		captive center contact	assembly	note
		A	B			
5 /50/ S + D	R141 207 000	5.6	1.05	no	M01	
5 /50/ S + D	R141 208 000	5.6	1.05	yes	M01	
.141"	R141 227 000	3.65	1.05	no	M10	semi-rigid cable

### STRAIGHT JACKS FULL CRIMP TYPE FOR FLEXIBLE CABLES

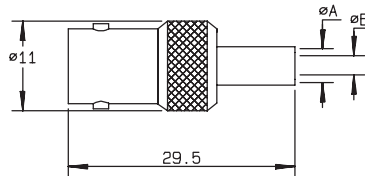

cable	part number	dimensions		captive center contact	assembly	note
		A	B			
2.6 /50/ S	R141 217 000		0.57	yes	M05	
5 /50/ S	R141 237 000*	5.5	1.05	yes	M07	single piece body
5 /50/ D	R141 220 000	5.5	1.05	yes	M07	single piece body

For others types of cables (75Ω, 93Ω or BT cables), please see "additional connectors" on page 36-37.

\* Packaging = 100 pieces.

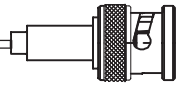

## STRAIGHT SQUARE FLANGE JACKS CLAMP TYPE FOR FLEXIBLE CABLES

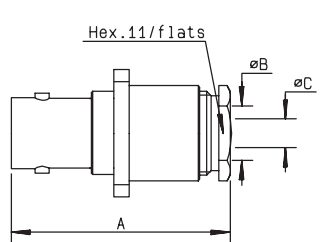

Fig. 1

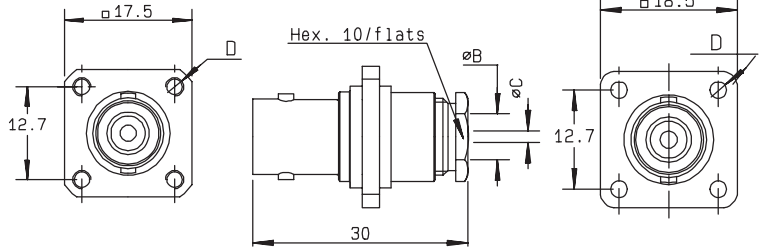

Fig. 2

cable	part number	fig.	dimensions				captive center contact	assembly	cut out	note
			A	B	C	D				
2 /50/ S+ D	R141 253 000	1	29.5	2.2	0.6	3-56-UNF-2B	yes	M02	P01	
2.6 /50/ S+ D	R141 254 000*	1	29.5	3.1	0.6	3-56-UNF-2B	yes	M02	P01	
2.6 /50/ S+ D	R141 278 000	1	29.5	3.1	0.6	2.7	yes	M02	P01	
2.6 /50/ S+ D	R141 277 000	2		3	0.6	2.6	yes	M02	P02	insulated flange
5 /50/ S+ D	R141 258 000	1	30	5.6	1.05	3-56-UNF-2B	no	M01	P01	
5 /50/ S+ D	R141 259 000●	1	30	5.6	1.05	2.6	no	M01	P01	
5 /50/ S+ D	R141 256 000	2		5.6	1.05	2.6	no	M03	P02	insulated flange

## STRAIGHT SQUARE FLANGE JACKS FULL CRIMP TYPE FOR FLEXIBLE CABLES

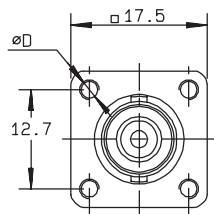

Fig. 1

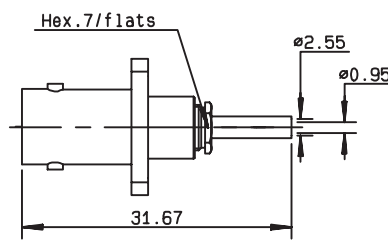

Fig. 2

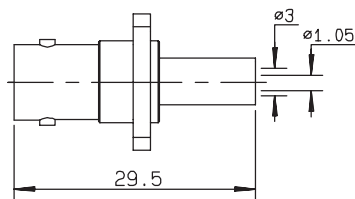
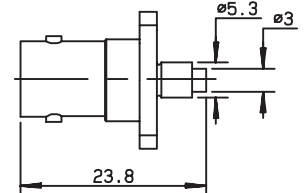

Fig. 3

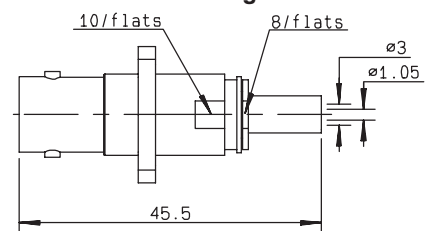

Fig. 4

cable	part number	fig.	captive center contact	assembly	cut out	note
2 /50/ S	R141 285 000●	1	yes	M13	P03	
2.6 /50/ S	R141 290 200●	2	yes	M12	P04	reverse crimping
5 /50/ S	R141 292 000	3	yes	M07	P01	single piece body
5 /50/ D	R141 297 000	4	yes	M08	P01	

For others types of cables (75Ω, 93Ω or BT cables), please see "additional connectors" on page 36-37.

● Upon request

\* Packaging = 100 pieces.

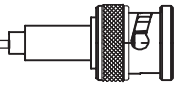

## STRAIGHT BULKHEAD JACKS CLAMP TYPE

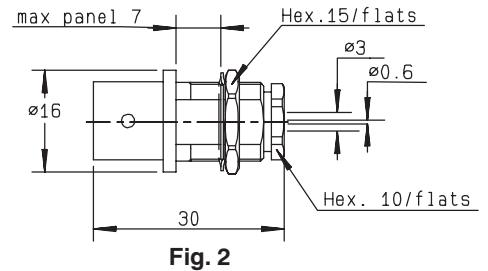
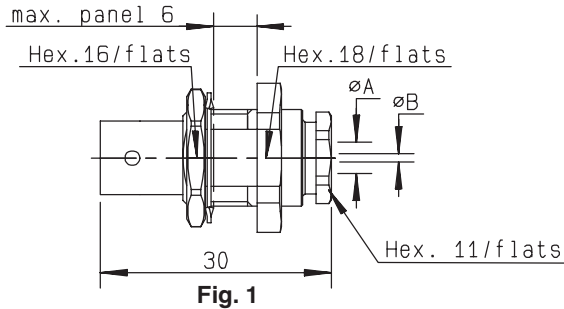

cable	part number	fig.	dimensions			captive center contact	assembly	cut out	note
			A	B					
2 /50/ S	R141 323 000*	1	2.2	0.6		yes	M02	P05	fully sealed
2.6 /50/ S	R141 304 000*	2				yes	M02	P05	fully sealed
2.6 /50/ S	R141 324 000	1	3.1	0.6		yes	M02	P05	fully sealed
5 /50/ S + D	R141 327 000*	1	5.6	1.05		no	M01	P05	panel sealed
.141"	R141 338 000●	1	3.65	1.05		no	M10	P05	panel sealed/semi-rigid cable

## STRAIGHT BULKHEAD JACKS CRIMP TYPE FOR FLEXIBLE CABLES

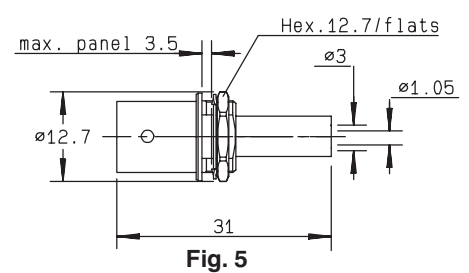
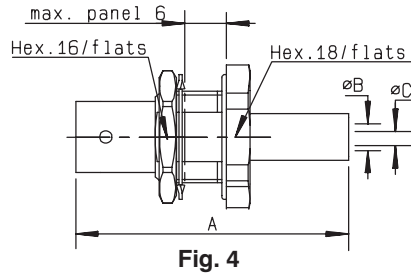
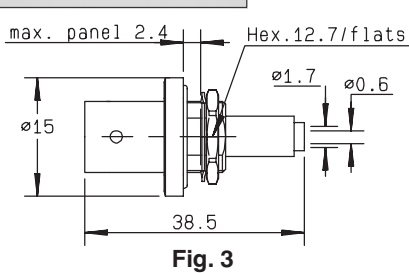
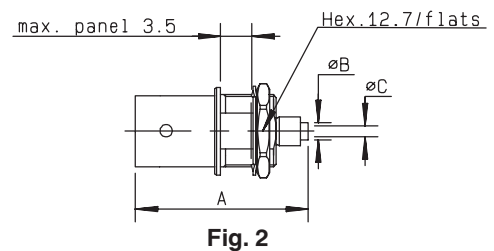
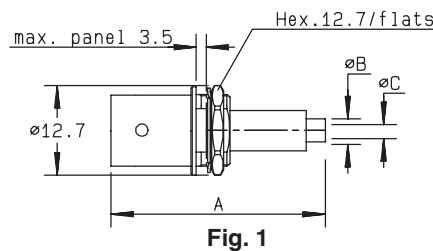

cable	part number	fig.	dimensions			captive center contact	assembly	cut out	note
			A	B	C				
2 /50/ S	R141 303 503●*	2	25.4	2	0.4	yes	M12	P07	reverse crimping
2 /50/ D	R141 301 000●	1	33.35	1.1	0.6	yes	M05	P07	
2.6 /50/ S	R141 306 000*	1	34	1.7	0.6	yes	M05	P07	
2.6 /50/ S	R141 306 503	2	26	2.95	0.6	yes	M12	P07	reverse crimping
2.6 /50/ S	R141 331 400●	3				yes	M05	P07	panel sealed
2.6 /50/ S	R141 331 500*	4	38.5	1.7	0.6	yes	M05	P09	panel sealed
5 /50/ S	R141 308 000	5	31	3	1.05	yes	M07	P07	single piece body
5 /50/ S	R141 332 500	4	35.5	3.1	1.05	yes	M07	P05 or P09	panel sealed/single piece body

For others types of cables (75Ω, 93Ω or BT cables), please see "additional connectors" on page 36-37.

● Upon request

\* Packaging = 100 pieces.

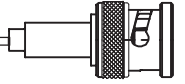

### FLANGE RECEPTACLES

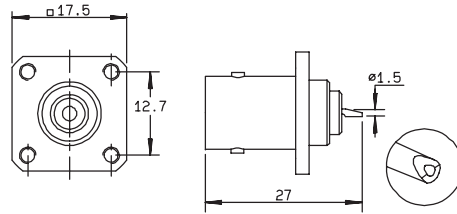
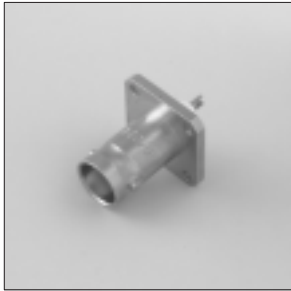

Fig. 1

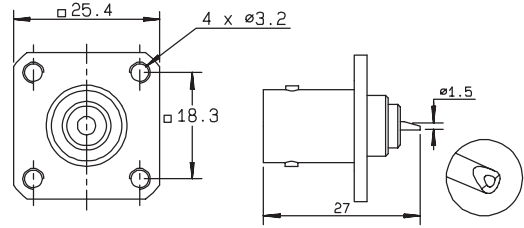

Fig. 2

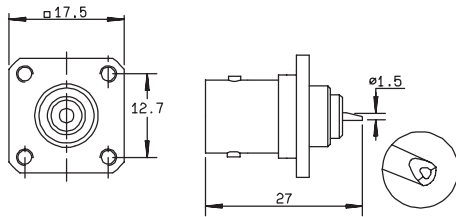

Fig. 3

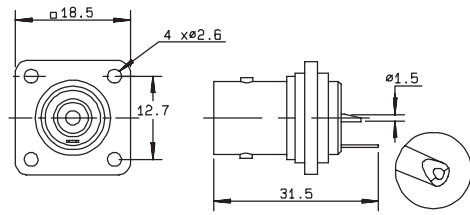

Fig. 4

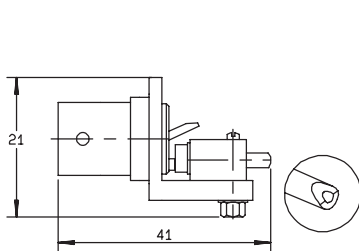

Fig. 5

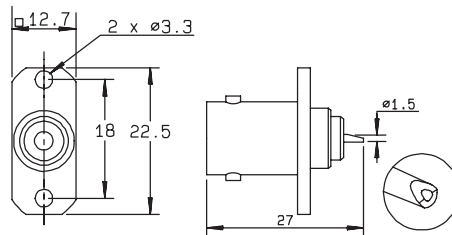

Fig. 6

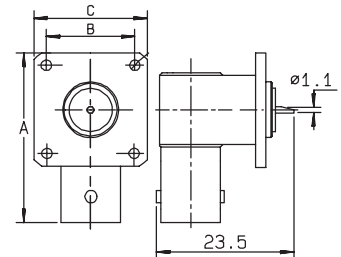

Fig. 7

part number	fig.	dimensions			captive center contact	cut out	flange holes	note
		A	B	C				
R141 403 000	1				yes	P14	4 x M2.5	
R141 403 500●	2				yes	P13		flange dimensions of N series (1)
R141 404 000	3				yes	P11	4 x M2.5	
R141 406 000*	1				yes	P14	4 x 2.6	
R141 407 000	3				yes	P11	4 x 2.6	
R141 410 000	4				yes	P02		insulated flange/solder tag
R141 439 000	5				yes	P12	4 x M2.5	auxiliary contact
R141 453 000	6				yes	P16		2 hole flange
R141 653 000	7	27.6	13.5	19	yes	P18	4 x 3.3	right angle receptacle
R141 654 000	7	26.9	12.7	17.5	yes	P19	4 x 2.6	right angle receptacle

(1) Ask our catalog D1 161 CE for N series.

● Upon request

\* Packaging = 100 pieces.

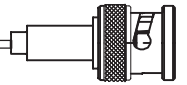

### STRAIGHT BULKHEAD RECEPTACLES WITH SOLDER POT

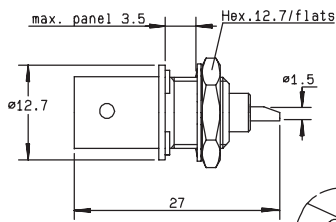

Fig. 1

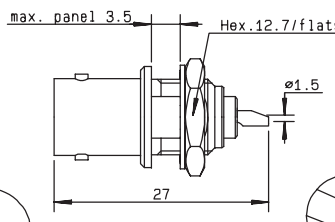

Fig. 2

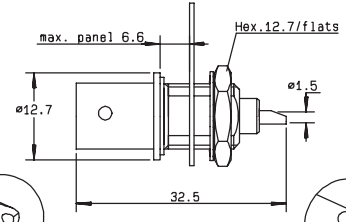

Fig. 3

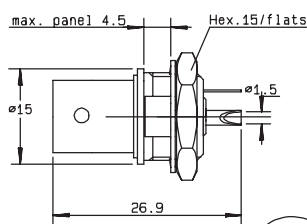

Fig. 4

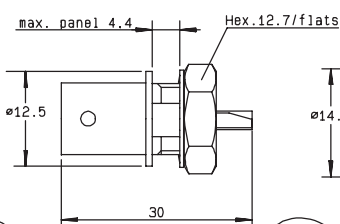

Fig. 5

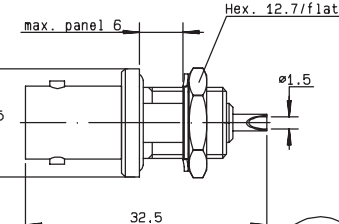

Fig. 6

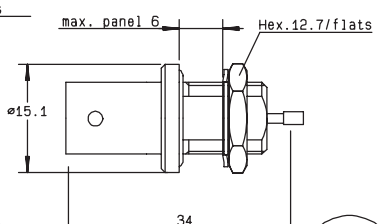
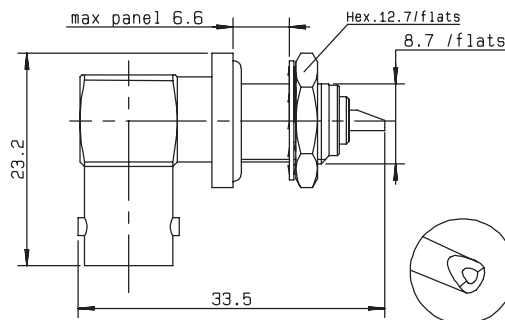

Fig. 7

part number	fig.	captive center contact	cut out	note
R141 554 000	1	yes	P20	
R141 557 000*	2	yes	P07	
R141 559 000	3	yes	P07	solder tag
R141 572 000*	4	yes	P05	insulated receptacle + solder tag
R141 574 000	5	yes	P07	insulated receptacle + solder tag
R141 603 000	6	yes	P22	fully sealed/Q200-5 insulator
R141 605 000	6	yes	P22	fully sealed
R141 625 000	7	yes	P07	hermetically sealed

### RIGHT ANGLE BULKHEAD RECEPTACLE WITH SOLDER POT



part number	captive center contact	cut out
R141 680 000	yes	P07

\* Packaging = 100 pieces.

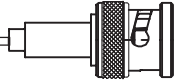

### PRESS MOUNT RECEPTACLES

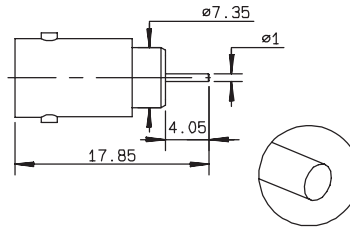

part number	captive center contact	cut out
R141 500 200●	yes	P10

### MALE RECEPTACLES

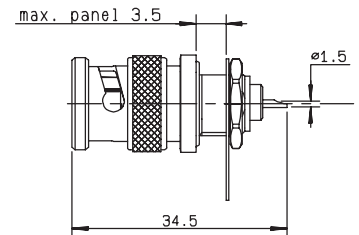
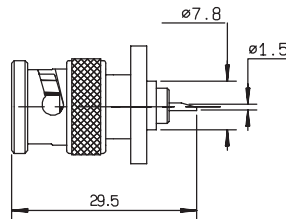
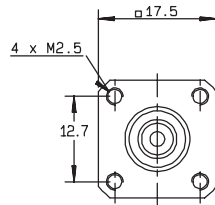
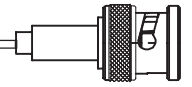

Fig. 1

Fig. 2

part number	fig.	captive center contact	cut out	note
R141 440 000	1	yes	P17	
R141 580 000	2	yes	P07	panel sealed/solder tag

● Upon request



## STRAIGHT PCB FEMALE RECEPTACLES

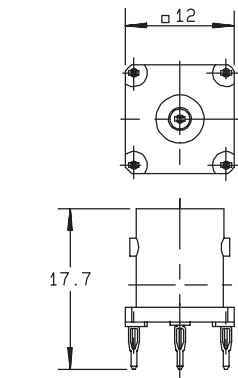

Fig. 1

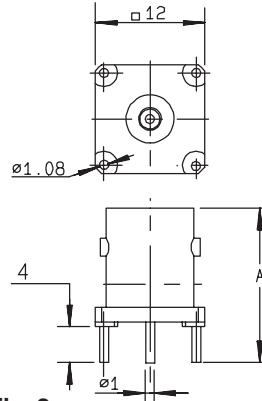

Fig. 2

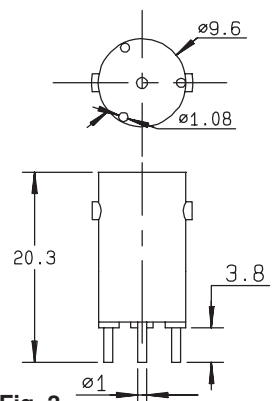

Fig. 3

part number	fig.	dimension A	captive center contact	PCB pattern	assembly	note
R141 416 000●	1		yes	P32	M15	press-fit pins / packaging 20
R141 426 000	2	17	yes	P24		
R141 426 165●*	2	26	yes	P24		tin lead legs
R141 508 200●*	3		yes	P23		

## RIGHT ANGLE PCB FEMALE RECEPTACLES

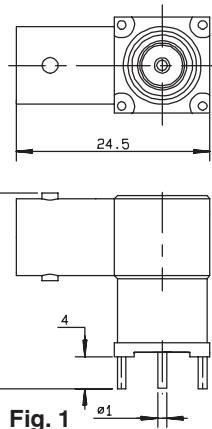

Fig. 1

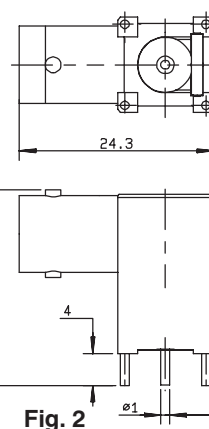

Fig. 2

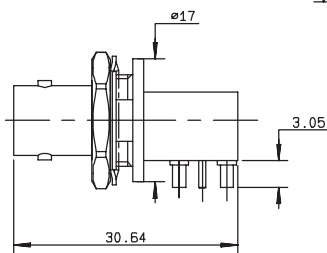

Fig. 3

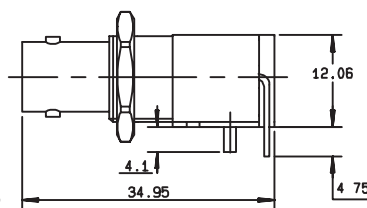

Fig. 4

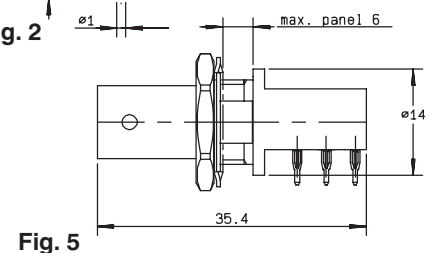

Fig. 5

part number	fig.	captive center contact	PCB pattern	assembly	finish	cut out	note
R141 665 000	1	yes	P24		Nickel		
R141 665 030●	2	yes	P24		Nickel		tin lead legs
R141 676 121●	3	yes	P29		Nickel	P15	rear mount
R141 676 423●	4	yes	P25		Gold	P31	rear mount + washer
R141 676 433●	4	yes	P25		Gold	P05	rear mount+2 insulated washers
R141 684 130	5	yes	P30	M16	Nickel	P09	Packaging 10/press-fit pins

● Upon request

\* Packaging = 100 pieces.



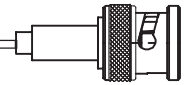

## IN SERIES ADAPTERS

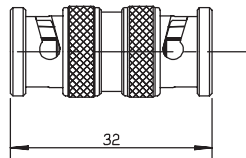

Fig. 1

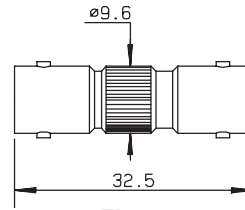

Fig. 2

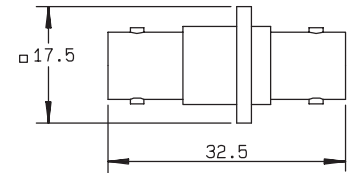

Fig. 3

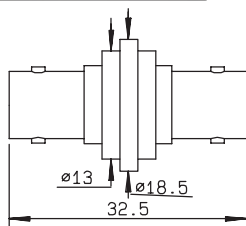

Fig. 4

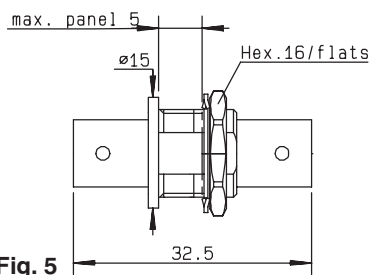

Fig. 5

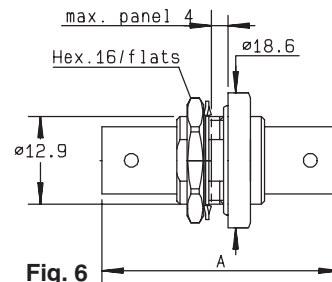

Fig. 6

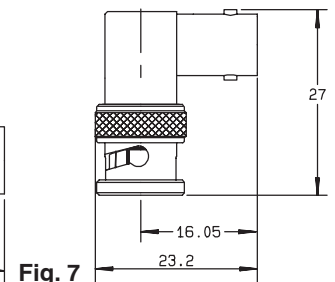

Fig. 7

part number	fig.	captive center contact	dimension A	flange holes	cut out	note
R141 703 000	1	yes				male - male
R141 704 000*	2	yes				female - female
R141 710 000	3	yes		4 x M2,5	P27	female - female square flange
R141 717 000	4	yes		4 x 2,6	P02	female - female square insulated flange
R141 720 000	5	yes			P05	female - female bulkhead
R141 723 000	5	yes			P05 or P09	female - female insulated bulkhead
R141 730 000	6	yes	35.7		P05	female - female panel sealed bulkhead
R141 753 000	6	yes	35.3		P05	female - female hermetically sealed bulkhead
R141 770 000	7	yes				male - female right angle

## CROSS AND TEE IN SERIES ADAPTERS

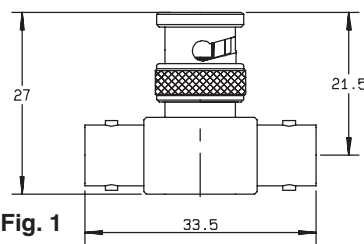

Fig. 1

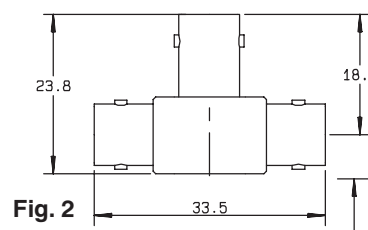

Fig. 2

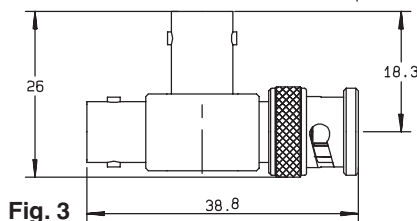

Fig. 3

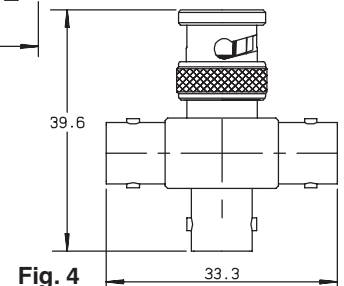

Fig. 4

part number	fig.	captive center contact	note
R141 780 000	1	yes	male / female-female tee
R141 782 000	2	yes	female / female-female tee
R141 789 000	3	yes	female / female-male tee
R141 799 000 •	4	yes	male / female-female-female cross

• Upon request

\* Packaging = 100 pieces.



## MALE AND FEMALE CAPS

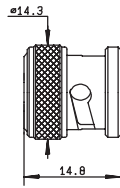

Fig. 1

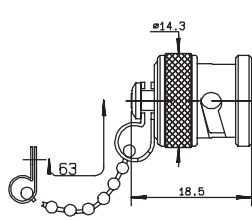

Fig. 2

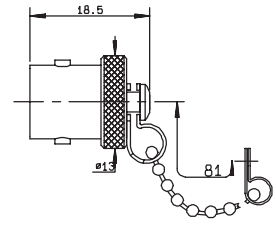
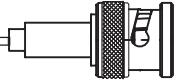

Fig. 3

part number	fig.	note
R141 802 000	1	male
R141 812 000	2	male with chain
R141 812 010* ●	2	male with chain
R141 842 000	3	female with chain
R141 862 000	2	male short circuit/ with chain

● Upon request

\* Packaging = 100 pieces.



TEST/CHARACTERISTICS	STANDARD REFERENCE	VALUES/REMARKS
----------------------	--------------------	----------------

### ELECTRICAL CHARACTERISTICS

Impedance		75 Ω
Frequency range		DC-1 GHz
V.S.W.R. max <i>Straight models cable group : 2.6/75, 5/75, 6/75, 8/75, 10 + 11/75</i> <i>Right angle models 2.6/75, 6/75</i>		1.30 1.35
Insertion loss <i>straight connector</i> <i>right-angle connector</i>		0.2 dB max at 1 GHz 0.3 dB max at 1 GHz
RF Leakage		- 55 dB min from 2 to 3 GHz
Insulation resistance		5000 MΩ min
Contact resistance <i>center contact</i> <i>outer contact</i>	MIL	1.5 mΩ 0.2 mΩ
Working voltage in VRMS <i>at sea level</i> <i>(at 21 000m)</i>		500 125
Dielectric withstanding voltage in VRMS <i>at sea level</i> <i>(at 21 000m)</i>		1500 375
RF testing voltage in VRMS <i>sea level (5 MHz)</i>		1000

### MECHANICAL CHARACTERISTICS

Durability		500 matings
Force to engage and disengage <i>axial</i> <i>torque</i>		13.6 N max 28.6 Ncm
Coupling nut retention force	MIL	445 N
Cable retention force <i>cable 2.6/75, 5/75, 6/75, 8/75, 10 + 11/75</i>		340 N
Center contact retention force		

### ENVIRONMENTAL CHARACTERISTICS

Temperature range <i>flexible cables</i>	MIL	- 65°C + 165°C
Thermo cycling test		MIL STD 202, method 107, condition B
Thermal shock		
High temperature endurance		MIL STD 202, method 108
Corrosion salt spray		MIL STD 202, method 101, condition B
Vibration		MIL STD 202, method 204, condition B
Shock		MIL STD 202, method 213, condition G
Moisture resistance		MIL STD 202, method 106
Hermetic test		MIL STD 202, method 112, condition C vacuum 10 <sup>-6</sup> Hgmm (Torr) leakage rate < 10 <sup>-6</sup> atm/cm <sup>3</sup> /s
Barometric pressure		Pressure test : 3.5 bars; duration : 2 mn; temperature : 15° C to 25 °C

### MATERIALS

Bodies		Brass
Center contact <i>male</i> <i>female</i>		Brass Bronze or heat treated beryllium following QQ-C-530
Nut		Brass
Insulator		PTFE
Gasket		Silicon rubber

### PLATINGS

Bodies		Nickel
Center contacts		Gold

Standard packaging : unit

All dimensions are given in mm.

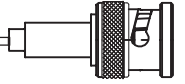

### STRAIGHT PLUGS CLAMP TYPE FOR FLEXIBLE CABLES

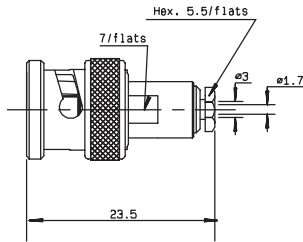

Fig. 1

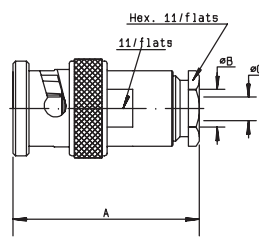

Fig. 2

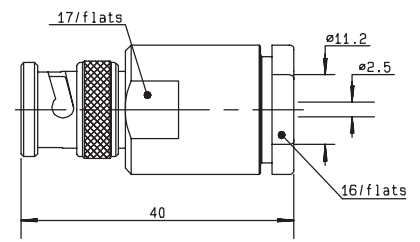

Fig. 3

cable	part number	fig.	dimensions			captive center contact	assembly
			A	B	C		
2.6 /75/ S	R142 004 000	1				yes	M04
6 /75/ S	R142 016 000	2	28	6.6	0.75	yes	M01
8 /75/ S + D	R142 017 000	2	45.5	9.1	1.5	yes	M03
10 + 11 /75 S + D	R142 018 000	3				yes	M01

### STRAIGHT PLUGS FULL CRIMP TYPE FOR FLEXIBLE CABLES

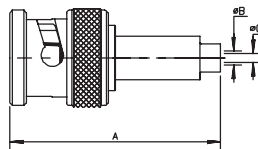

Fig. 1

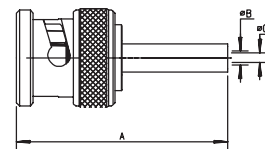
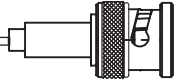

Fig. 2

cable	part number	fig.	dimensions			captive center contact	assembly	note
			A	B	C			
2.6 /75/ S	R142 076 000*	1	31	1.8	0.4	yes	M05	
5 /75/ D	R142 083 000	2	27.3	5.5	0.75	yes	M07	
6 /75/ S	R142 085 000*	2	28	6.6	0.75	yes	M07	single piece body
10 /75/ S	R142 095 000	2	28	11.05	1.35	yes	M07	single piece body

For others types of cables (75Ω, 93Ω or BT cables), please see "additional connectors" on page 36-37.

\* Packaging = 100 pieces.



### RIGHT ANGLE PLUGS CLAMP TYPE FOR FLEXIBLE CABLES

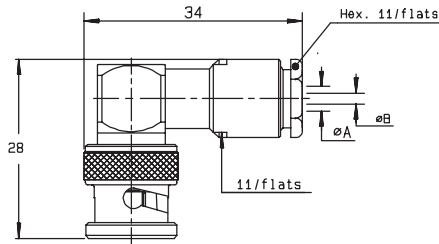
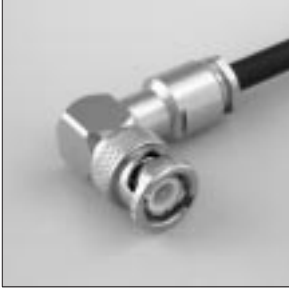

Fig. 1

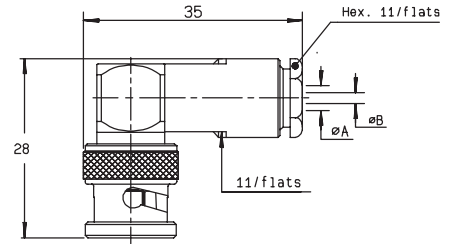
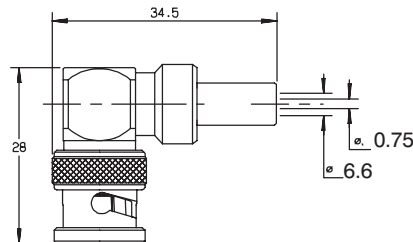

Fig. 2

cable	part number	fig.	dimensions		captive center contact	assembly
			A	B		
2.6 /75/ S	R142 154 000	1	3.1	0.6	yes	M02
6 /75/ S	R142 157 000	2	6.6	0.75	yes	M01

### RIGHT ANGLE PLUGS FULL CRIMP TYPE FOR FLEXIBLE CABLES



cable	part number	captive center contact	assembly
6 /75/ S	R142 184 000	yes	M07

For others types of cables (75Ω, 93Ω or BT cables), please see "additional connectors" on page 36-37.

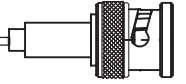

## STRAIGHT JACKS FULL CRIMP TYPE FOR FLEXIBLE CABLES

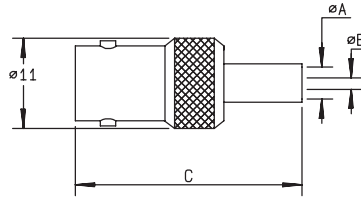

cable	part number	dimensions			captive center contact	assembly	note
		A	B	C			
2.6 /75/ S	R142 217 000	1.75	0.4	32.5	yes	M05	
6 /75/ S	R142 242 000*	6.6	0.75	29.5	yes	M07	single piece body

## STRAIGHT SQUARE FLANGE JACKS CLAMP TYPE FOR FLEXIBLE CABLES

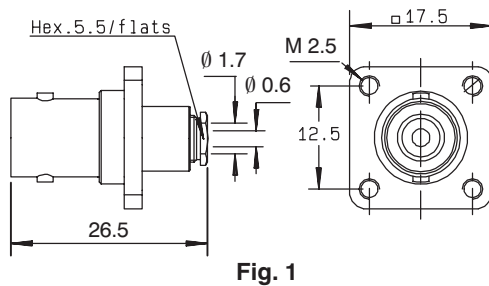

Fig. 1

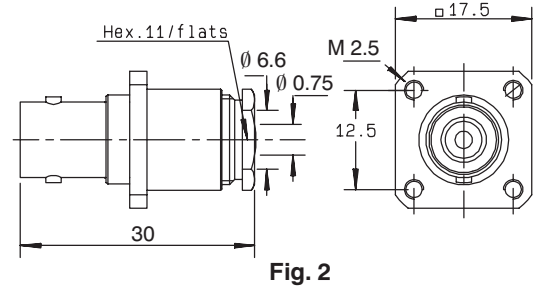
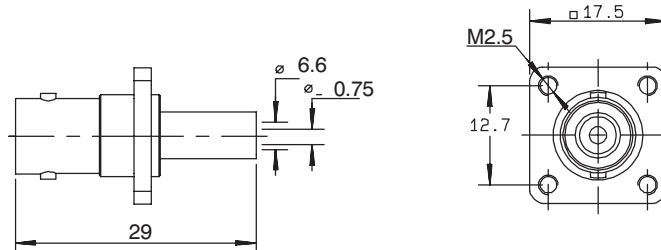

Fig. 2

cable	part number	fig.	captive center contact	assembly	cut out
2.6 /75/ S	R142 202 000	1	yes	M04	P01
6 /75/ S	R142 268 000	2	yes	M01	P01

## STRAIGHT SQUARE FLANGE JACKS FULL CRIMP TYPE FOR FLEXIBLE CABLES



cable	part number	captive center contact	assembly	cut out	note
6 /75/ S	R142 295 000	yes	M07	P01	single piece body

For others types of cables (75Ω, 93Ω or BT cables), please see "additional connectors" on page 36-37.

\* Packaging = 100 pieces.

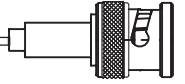

## STRAIGHT BULKHEAD JACKS CLAMP TYPE FOR FLEXIBLE CABLES

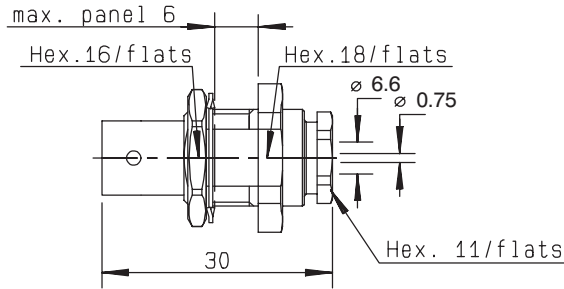

cable	part number	captive center contact	assembly	cut out	note
6 /75/ S	R142 329 000	yes	M01	P05	panel sealed

## STRAIGHT BULKHEAD JACKS CRIMP TYPE FOR FLEXIBLE CABLES

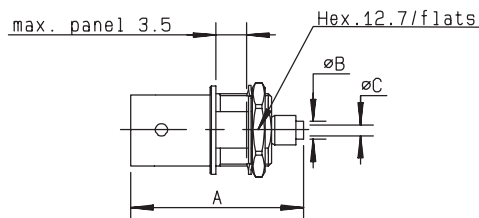

Fig. 1

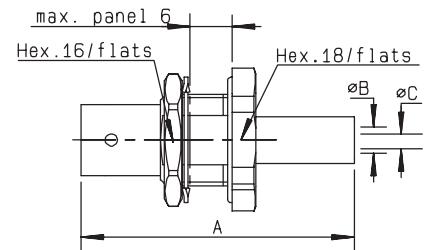

Fig. 2

cable	part number	fig.	dimensions			captive center contact	assembly	cut out	note
			A	B	C				
2.6 /75/ S	R142 306 500*	1	26	2.95	0.4	yes	M12	P07	reverse crimping
2.6 /75/ S	R142 306 503*	1	26	2.95	0.4	yes	M12	P07	reverse crimping
2.6 /75/ S	R142 306 520●*	1	26	2.95	0.6	yes	M12	P07	reverse crimping
2.6 /75/ S	R142 331 011●	2	38	1.75	0.4	yes	M05	P08	panel sealed/ silver plated

For others types of cables (75Ω, 93Ω or BT cables), please see "additional connectors" on page 36-37.

● Upon request

\* Packaging = 100 pieces.



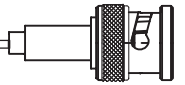

### STRAIGHT SQUARE FLANGE RECEPTACLES WITH SOLDER POT

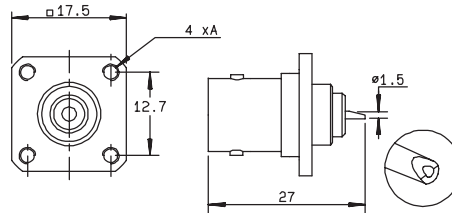
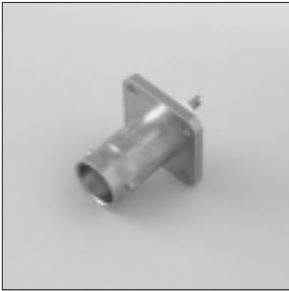

part number	captive center contact	cut out	flange holes A
R142 407 000	yes	P11	4 x 2,6
R142 412 000	yes	P11	4 x M2.5

### STRAIGHT BULKHEAD RECEPTACLES WITH SOLDER POT

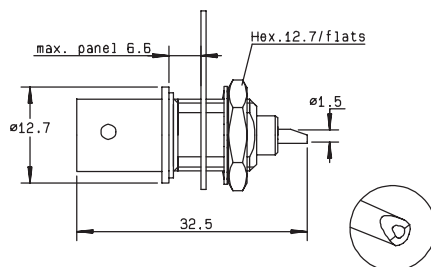

Fig. 1

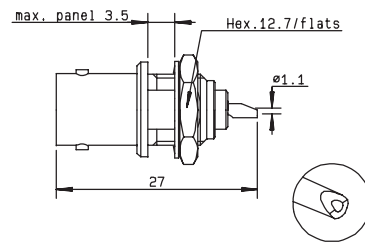
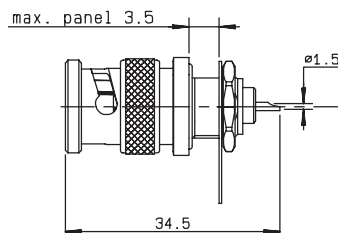

Fig. 2

part number	fig.	captive center contact	cut out	note
R142 562 000	1	yes	P07	
R142 562 290●	2	yes	P07	with 2 insulated washers + solder tag

### BULKHEAD MALE RECEPTACLE WITH SOLDER POT



part number	captive center contact	cut out	note
R142 580 000	yes	P07	panel sealed + solder tag

● Upon request

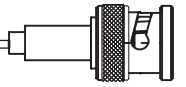

### STRAIGHT PCB FEMALE RECEPTACLES

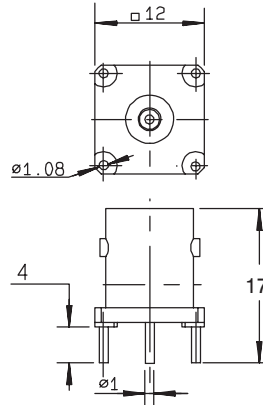

part number	captive center contact	PCB pattern
R142 426 000●	yes	P24
R142 426 030●*	yes	P24

### IN SERIES ADAPTERS

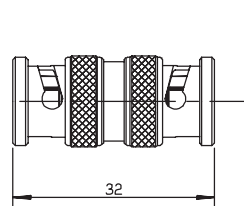

Fig. 1

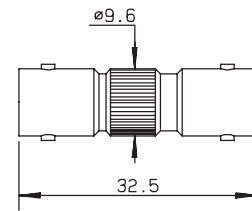

Fig. 2

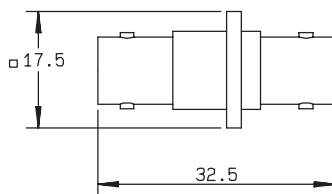

Fig. 3

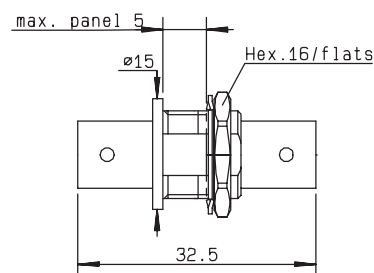

Fig. 4

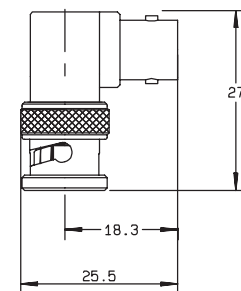
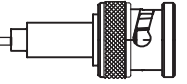

Fig. 5

part number	fig.	captive center contact	cut out	note
R142 703 000	1	yes		male - male
R142 704 000*	2	yes		female - female
R142 710 000	3	yes	P01	female - female square flange
R142 720 000*	4	yes	P05	female - female bulkhead
R142 723 000	4	yes	P05 or P09	female - female insulated bulkhead
R142 770 000	5	yes		male - female right angle

● Upon request

\* Packaging = 100 pieces.



## TEE IN SERIES ADAPTERS

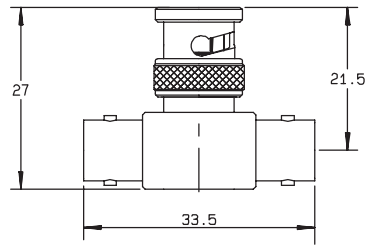

Fig. 1

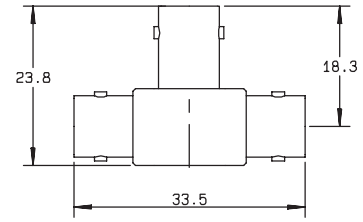

Fig. 2

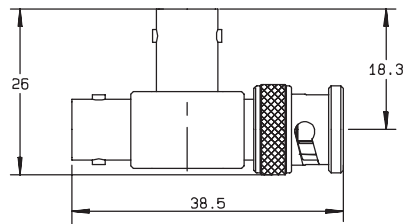
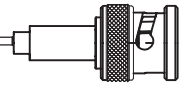

Fig. 3

part number	fig.	captive center contact	note
R142 780 000*	1	yes	male / female-female tee
R142 782 000	2	yes	female / female-female tee
R142 789 000	3	yes	female / female-male tee

\* Packaging = 100 pieces.



For more information regarding these connectors, please consult us.

### CONNECTORS WITH FLAT GASKET

R141  
↓  
BNC 50 Ω

R142  
↓  
BNC 75 Ω

P/N	Description	captive center contact
R141 007 000	straight plug clamp type for 5/50/S+D cable	NO
R141 011 000	straight plug clamp type for 6/75/S cable	NO
R141 015 000	straight plug clamp type for 6/75/S cable	NO
R141 154 000	right angle plug clamp type for 2.6/50/S+D cable	YES
R141 206 000	straight jack clamp type for 5/50/S+D cable	NO
R141 209 000	straight jack clamp type for 6/75/S cable	NO
R141 256 000	straight square flange jack clamp type for 5/50/S+D cable	NO
R141 257 000	straight square flange jack clamp type for 5/50/S cable	NO
R141 261 000	straight square flange jack clamp type for 6/75/S cable	NO
R141 264 000	straight insulated square flange jack clamp type for 6/75/S cable	NO
R142 017 000	straight plug clamp type for 8/75/S+D cable	YES

### 50 Ω CONNECTORS FOR 75 Ω or 93 Ω CABLE

#### 75 Ω Cable

P/N	Description	captive center contact
R141 004 000	straight plug clamp type for 2,6/75/S cable	YES
R141 011 000	straight plug clamp type for 6/75/S cable	NO
R141 013 000	straight plug clamp type for 6/75/S cable	NO
R141 014 000	straight plug clamp type for 6/75/S cable	YES
R141 015 000	straight plug clamp type for 6/75/S cable	NO
R141 074 000	straight plug clamp type for 6/75/S cable	YES
R141 082 280	straight plug crimp type for PH18 cable	YES
R141 154 000	right angle plug clamp type for 2,6/75/D cable	YES
R141 157 000	right angle plug clamp type for 6/75/S cable	YES
R141 184 000	right angle plug crimp type for 6/75/S cable	YES
R141 209 000	straight jack clamp type for 6/75/S cable	NO
R141 210 000	straight jack clamp type for 6/75/S cable	YES
R141 254 000	straight square flange jack clamp type for 2,6/75/S cable	YES
R141 261 000	straight square flange jack clamp type for 6/75/S cable	NO
R141 264 000	straight insulated square flange jack clamp type for 6/75/S cable	NO
R141 277 000	straight insulated square flange jack clamp type for 2,6/75/S cable	YES
R141 278 000	straight square flange jack clamp type for 2,6/75/S cable	YES
R141 329 000	straight bulkhead jack clamp type for 6/75/S cable	YES
R141 334 161	straight bulkhead jack crimp type for 6/75/S cable	YES
R141 334 500	straight bulkhead jack crimp type for 6/75/S cable	YES

#### 93 Ω Cable

P/N	Description	captive center contact
R141 013 000	straight plug clamp type for 6/93/S cable	NO
R141 014 000	straight plug clamp type for 6/93/S cable	YES
R141 077 000	straight plug crimp type for 3,8/93/S cable	YES

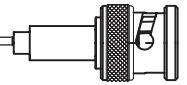

### 75 Ω CONNECTORS FOR 93 Ω CABLE

P/N	Description
R142 016 000	straight plug clamp type for 6/93/S cable
R142 085 000	straight plug crimp type for 6/93/S cable

### CONNECTORS FOR BT OR SPECIAL CABLES *Ask for our BT43 catalog : P/N D1 214 CE.*

P/N	Description	Packaging
R141 005 000	straight plug clamp type dia 3,5/50, PPD cable	unit
R141 015 000	straight plug clamp type dia 6/75/S, 75PD cable	unit
R141 082 280	straight plug crimp type for 6/75, PH 18 cable	unit
R142 080 000	straight plug crimp type for 3,8/75/T, ET 33542 cable	unit
R142 081 100	straight plug crimp type for 3,6/75/D, P46431 cable	unit
R142 081 120	straight plug crimp type for BT3002 / TZC 75024 cable	unit
R142 081 130	straight plug crimp type for BT3002 / TZC 75024 cable	100 pieces
R142 081 320	straight plug crimp type for BT2001 cable	unit
R142 081 330	straight plug crimp type for BT2001 cable	100 pieces
R142 083 320	straight plug crimp type for BT2002 cable	unit
R142 083 330	straight plug crimp type for BT2002 cable	100 pieces
R142 085 230	straight plug crimp type for BICC T3304 cable	unit
R142 086 320	straight plug crimp type for BT2003 cable	unit
R142 086 340	straight plug crimp type for BT2003 cable	100 pieces
R142 177 200	right angle plug crimp type for BT3002 / TZC 75024 cable	100 pieces
R142 177 200W	right angle plug crimp type for BT3002 / TZC 75024 cable	unit
R142 181 200	right angle plug crimp type for BT2002 cable	100 pieces
R142 181 200W	right angle plug crimp type for BT2002 cable	unit
R142 185 200	right angle plug crimp type for BT2003 cable	100 pieces
R142 185 200W	right angle plug crimp type for BT2003 cable	unit
R142 325 100W	straight bulkhead jack crimp type for BT3002 / TZC 75024 cable	unit
R142 325 106	straight bulkhead jack crimp type for BT3002 / TZC 75024 cable	100 pieces

### CONNECTORS FOR DIGITAL BROADCAST APPLICATIONS *Special finish*

Connectors developed for NOKIA 0.6/2.8 AF 75 Ω cable.

P/N	Description	packaging	outer contact finish	body finish
R142 082 027	straight plug crimp type for 5/75/S cable	unit	BBR*	BBR*
R142 082 042	straight plug crimp type for 5/75/S cable	100 pieces	gold	BBR*
R142 082 042W	straight plug crimp type for 5/75/S cable	unit	gold	BBR*
R142 082 047	straight plug crimp type for 5/75/S cable	100 pieces	BBR*	BBR*
R142 720 023	female female bulkhead adapter	100 pieces	-	gold

\* BBR : Bright Bronze RADIALL.

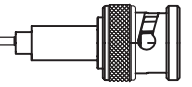

## SOLDER TAG

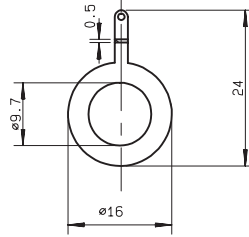

Fig.1

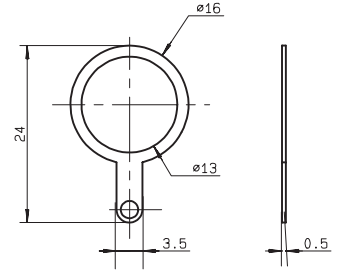
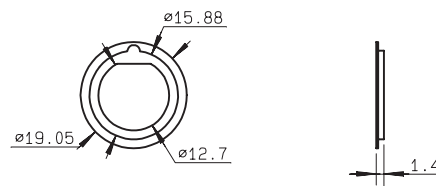
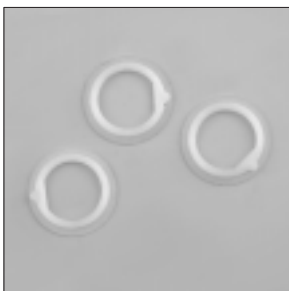

Fig.2

part number	Fig.	To be used on	Finish	Packaging
R280 490 020	1	R141 301 000	nickel	100 units
		R141 303 503		
		R141 306 000		
		R141 306 503		
		R141 308 000		
		R141 331 400		
		R141 557 000		
		R141 603 000		
R280 490 030	2	R141 304 000		
		R141 323 000		
		R141 324 000		
		R141 327 000		
		R141 331 500		
		R141 332 500		
		R141 338 000		
		R141 554 000		
R141 676 121				
R141 676 423				

## INSULATED WASHERS



part number	to be used on	material	packaging	cut out
R280 907 000	R141 304 000	R141 730 000	100 sets (200 washers)	P26
	R141 323 000	R141 753 000		
	R141 324 000			
	R141 327 000	R142 239 000		
	R141 332 500	R142 720 000		
	R141 338 000			

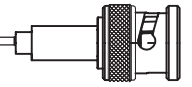

## HEATSHRINK SLEEVES

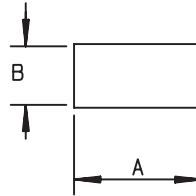
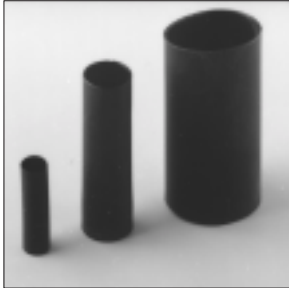

These heatshrink sleeves guarantee an IP65 moisture resistance on crimp type models and an IP 67 moisture resistance on clamp type models.

cable group	part number	dimensions		packaging
		A	B	
2 /50	R280 637 010	22	3.2	100
2.6 /50	R280 637 020	22	4.8	
5 /50	R280 637 030	25	6.4	
10 + 11 /50	R280 637 040	45	12	

## BOOTS (material : PVC)

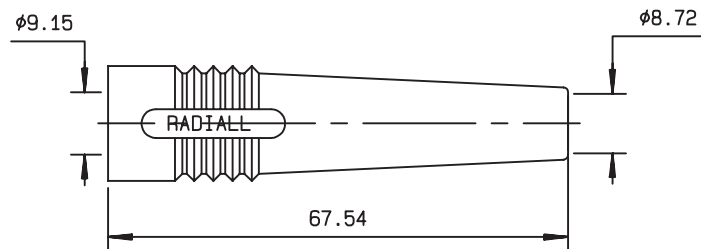
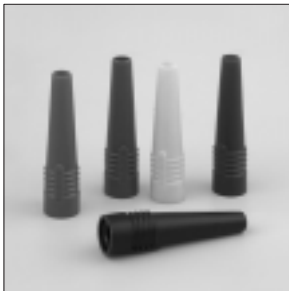

color	cable group		
	2.6/50	5/50	6/75
Black	R280 566 000	R280 570 000 *	R280 590 000
Red	R280 566 001	R280 571 000	R280 591 000
Green	R280 566 002	R280 572 000	R280 592 000
Blue	R280 566 003	R280 573 000	R280 593 000
Yellow	R280 566 004	R280 574 000	R280 594 000
Grey	R280 566 005	R280 575 000	R280 595 000
White	R280 566 006	R280 576 000	R280 596 000
Brown	R280 566 007 ●	R280 577 000	R280 597 000
Orange	R280 566 008 ●	R280 578 000	R280 598 000
Violet	R280 566 009 ●	R280 579 000	R280 599 000
Nature	R280 566 010 ●	R280 580 000 ●	R280 600 000

● Upon request

Standard packaging = 10 pieces - \* packaging = 100 pieces.



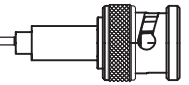

R191  
⇓  
50 Ω Adapters

R192  
⇓  
75 Ω Adapters

Ask for our full detailed catalog of COAXIAL BETWEEN SERIES ADAPTERS 50Ω & 75Ω : **D1 191 CE**

	BNC MALE	BNC MALE PUSH-ON <sup>(1)</sup>	BNC FEMALE	BNC FEMALE PUSH-ON <sup>(1)</sup>	BNC BULKHEAD FEMALE HERM.	BNC FLANGE FEMALE
MCX MALE	R191 471 000		R191 475 000 R192 475 007			
MCX FEMALE	R191 473 000 R192 473 007		R191 477 000			
SMA MALE	R191 301 000 R191 301 360*		R191 303 000			
SMA MALE PUSH-ON <sup>(1)</sup>			R191 303 502			
SMA FEMALE	R191 305 000		R191 307 000			
SMA FEMALE PUSH-ON*			R191 304 502			
SMB MALE	R191 209 000				R191 213 000	R191 212 000
SMB FEMALE	R191 214 000		R191 215 000*			
SMC MALE	R191 117 000		R191 120 000			
SMC FEMALE			R191 123 000		R191 124 000	
SMZ type 43 FEMALE			R192 486 000 R192 489 500 (right angle)			
1,6/5,6 MALE	R192 431 000		R192 432 000			
1,6/5,6 FEMALE	R192 430 000					
TNC MALE			R191 405 000			
TNC MALE PUSH-ON <sup>(1)</sup>			R191 405 500			
TNC FEMALE	R191 403 000					
N MALE	R191 417 000 R192 417 000	R191 417 500	R191 421 000 R192 421 000	R191 421 500		
N FEMALE	R191 419 000 R192 419 000		R192 418 000		R191 422 000	R191 426 000
N FEMALE FLANGE			R191 424 000			
C MALE			R191 429 000			
UHF MALE			R191 447 000*			
UHF FEMALE	R191 445 000					
HN MALE			R191 449 000			
2 SOCKETS DIA 2	R191 450 000					
2 SOCKETS DIA 4	R191 453 000					
1 SOCKET DIA 4	R191 454 000					
PC7	R191 013 000		R191 015 000			

\* packaging 100 pieces

<sup>(1)</sup> For PUSH-ON adapters, please ask for **D1 036 DE** catalog.

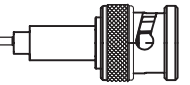

### RESISTIVE PADS (500W peak) (p. 42)

Average power (W)	Frequency range	Impedance ( $\Omega$ )	Male
1	DC – 1 GHz	$75 \pm 0.1\%$	<b>R404 412 000</b>
		$75 \pm 1\%$	<b>R404 442 000</b>
		$50 \pm 1\%$	<b>R404 441 000</b>

### LOW POWER TERMINATIONS (500W peak) (p. 42)

Average power (W)	Frequency range	Impedance ( $\Omega$ )	Male	Female
1	DC – 1 GHz	$50 \pm 2\%$	<b>R404 011 000</b>	<b>R404 013 000</b>
		$75 \pm 2\%$	<b>R404 012 000</b>	<b>R404 014 000</b>
	DC – 2.5 GHz	$50 \pm 2\%$	<b>R404 111 000</b>	<b>R404 112 000</b>
	DC – 8 GHz		<b>R404 110 000</b>	

### MEDIUM POWER TERMINATIONS (4 KW peak) (p. 43)

Average power (W)	Frequency range	Impedance ( $\Omega$ )	Male
6	DC – 2 GHz	$50 \pm 5\%$	<b>R404 505 000</b>
	DC – 8 GHz		<b>R404 510 000</b>
12	DC – 2 GHz		<b>R404 555 000</b>
	DC – 8 GHz		<b>R404 560 000</b>

### LOW LEVEL ATTENUATORS (100 W peak) (p. 43)

ATTENUATION (dB)	Frequency range (GHz)		
	DC – 2 GHz	DC – 3 GHz	DC – 8 GHz
3	<b>R412 403 000</b>	<b>R412 403 124</b>	<b>R414 403 000</b>
6	<b>R412 406 000</b>	<b>R412 406 124</b>	<b>R414 406 000</b>
10	<b>R412 410 000</b>	<b>R412 410 124</b>	<b>R414 410 000</b>
20	<b>R412 420 000</b>	<b>R412 420 124</b>	<b>R414 420 000</b>

### MEDIUM POWER ATTENUATORS (p. 44)

ATTENUATION (dB)	Frequency range (GHz)	Average power (Watts)
	DC – 4 GHz	
3	<b>R415 403 000</b>	15
6	<b>R415 406 000</b>	12
10	<b>R415 410 000</b>	10
20	<b>R415 420 000</b>	10

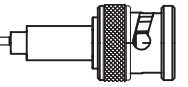

### RESISTIVE PADS (500W peak)

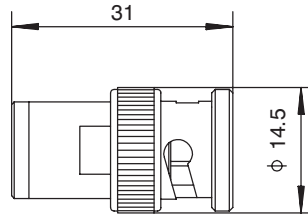

Part number	Frequency Range	Technical design	Impedance ( $\Omega$ )	Type	Weight (g)
R404 412 000	DC – 1 GHz	Resistive PAD	75 $\pm$ 0.1%	M	15
R404 441 000			50 $\pm$ 1%		
R404 442 000			75 $\pm$ 1%		

### LOW POWER TERMINATIONS (500W peak)

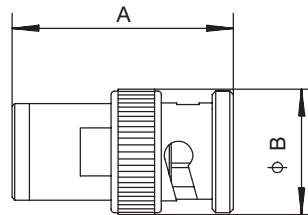

Part number	Freq. Range (GHz)	V.S.W.R. (max)					Power (W) Avg.	Impedance ( $\Omega$ )	Type	Dimensions (mm)		Weight (g)
		DC-0.5	0.5-1	1-2.5	2.5-4	4-8				A	B	
R404 011 000	DC – 1	1.08	1.15				1	50 $\pm$ 2%	M	31	14.5	15
R404 013 000								F	29	11		
R404 012 000								M	31	14.5		
R404 014 000								F	29	11		
R404 111 000	DC– 2.5	1.08	1.20			50 $\pm$ 2%		M	31	14.5		
R404 112 000						F		29	11			
R404 110 000	DC – 8	1.10			1.20	1.25		50 $\pm$ 5%	M	31	14.5	

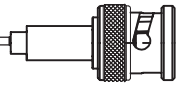

### MEDIUM POWER TERMINATIONS (4 KW peak)

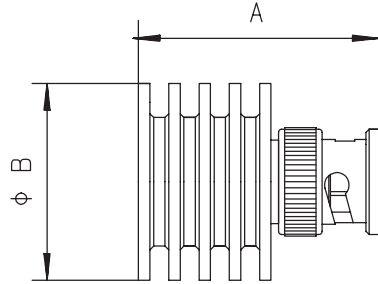
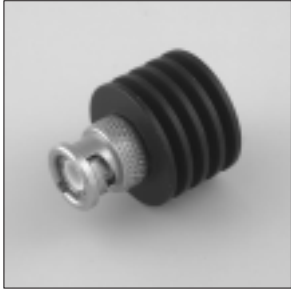

Part number	Freq. Range (GHz)	V.S.W.R. max			Power (W) Avg.	Impedance ( $\Omega$ )	Type	Dimensions (mm)		Weight (g)
		DC-2	2-4	4-8				A	B	
R404 505 000	DC - 2	1.10			6	$50 \pm 5\%$	M	34	26	26
R404 510 000	DC - 8		1.15	1.25						
R404 555 000	DC - 2				12			47	35	
R404 560 000	DC - 8		1.15	1.25						

### LOW LEVEL ATTENUATORS (100 W peak)

All these attenuators are available from 0 to 20 dB with 1 dB step

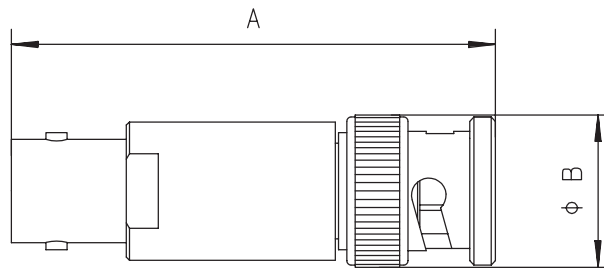

Part number	Freq. Range (GHz)	Attenuation					V.S.W.R.				Power (W) Avg.	Dimensions (mm)		Weight (g)
		Nom	Deviation				DC - 2	2-3	3-4	4-8		A	B	
R412 403 000	DC - 2	3	$\pm 0.35$				$\leq 1.20$				2	46.5	13	30
R412 406 000		6												
R412 410 000		10												
R412 420 000		20	$\pm 0.45$											
R412 403 124	DC - 3	3	$\pm 0.30$	$\pm 0.50$		$\leq 1.20$	$\leq 1.30$			1	32	17		
R412 406 124		6												
R412 410 124		10	$\pm 0.50$											
R412 420 124		20	$\pm 0.70$	$\pm 0.70$										
R414 403 000	DC - 8	3	$\pm 0.30$		$\pm 0.50$	$\leq 1.20$	$\leq 1.20$	$\leq 1.25$	2	46.5	13	30		
R414 406 000		6												
R414 410 000		10												
R414 420 000		20	$\pm 0.50$											

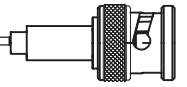

### MEDIUM POWER ATTENUATORS

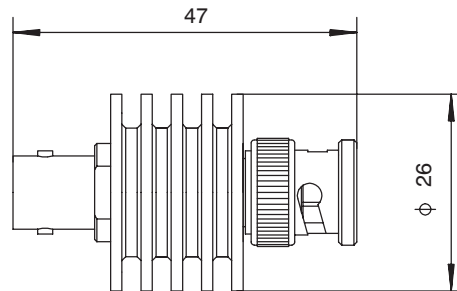

Part number	Freq. Range (GHz)	Attenuation		V.S.W.R. DC - 4	Power (W)		Weight (g)
		Nom	Deviation DC - 4		Avg.	Peak	
R415 403 000	DC - 4	3	± 0.50	≤ 1.30	15	250	70
R415 406 000		6			12		
R415 410 000		10			10		
R415 420 000		20			10		

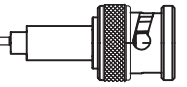

*Joule effect soldering device*

Compliant with European standards n° 89/336/CEE and 73/23/CEE (electromagnetic compatibility and low voltage)

It allows to solder :

- center contacts and bodies to semi-rigid cables,
- center contacts to flexible cables
- solder pot receptacles.

P/N of the soldering device : **R282 800 000** (80 W-shown above)  
**R282 800 001** (250 W).

Please ask for our leaflet about Joule effect soldering device  
**D1 035 DE.**

Radiall recommends to always carry out soldering operations in well ventilated areas and to make use of fume extraction equipment.

Our fume extraction device complies also with European standards n° 89/336/CEE , 89/392/CEE and 73/23/CEE.

Its flow is adjustable up to 240 m<sup>3</sup> /h and it uses active coal filter.

P/N of the fume extraction device : **R282 803 000.**



*Fume extraction device*

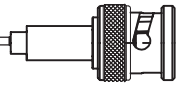

## KIT : BENDING OF SEMI-RIGID CABLES

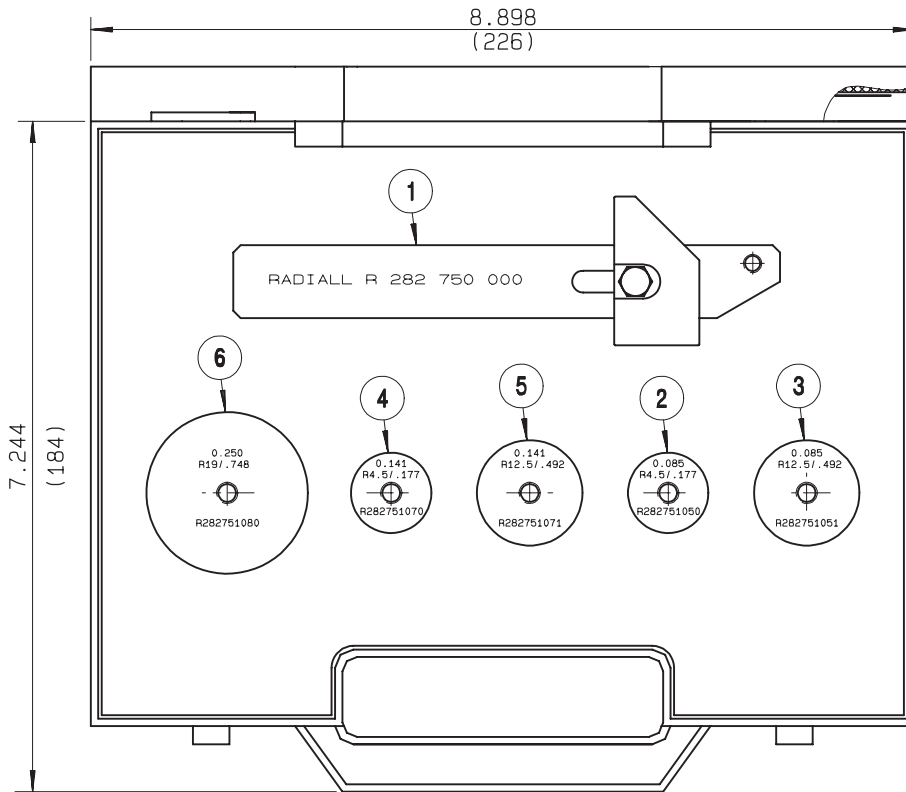

Part number

**R282 102 000**

NOMENCLATURE	OLD CROSS-REFERENCES
1 - R 282 750 000 Bending tool	730 11 000 (09)
2 - R 282 751 050 Bending gauge .085	730 11 040 (02)
3 - R 282 751 051 bending gauge .085	730 11 030 (01)
4 - R 282 751 070 Bending gauge .141	730 11 060 (04)
5 - R 282 751 071 Bending gauge .141	730 11 050 (03)
6 - R 282 751 080 Bending gauge .250	730 11 070 (05)

Inside the box, every part number can be ordered separately.

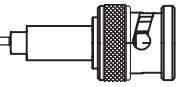

### RADIALL CRIMP TOOLS (DIES INCLUDED)

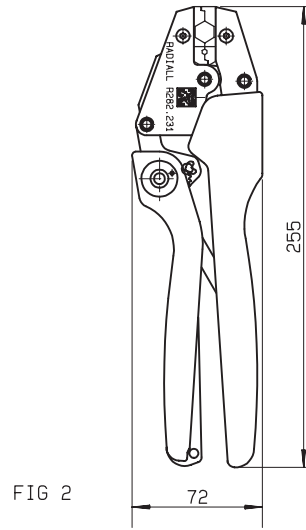
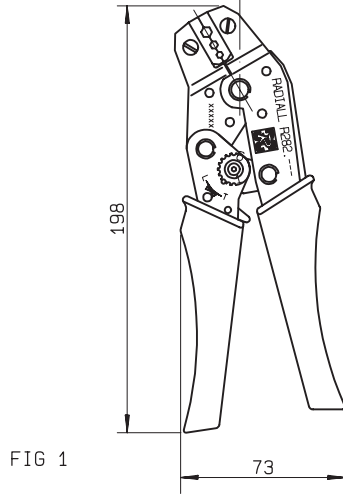

PART NUMBER	FIG.	CABLE GROUP	COLOR OF HANDLES			
R282 211 000	1	2/50 S - 2.6/50 S	RED	4.52 (0.178)	3.25 (0.128)	2.67 (0.105)
R282 223 000	1	5/50 S - 5/50 D	ORANGE	6.48 (0.255)	5.41 (0.213)	1.73 (0.068)
R282 231 000	2	10.3/50 S	YELLOW	10.54 (0.415)	2.54 (0.1)	

### MIL CRIMPING TOOL (MIL 22520/05-01) (DIES NOT INCLUDED)

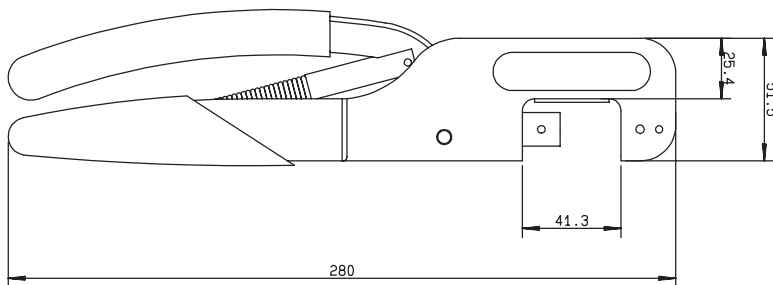

Part number

**R282 293 000**

### DIES

Part number	Cable group		
R282 235 003	2.6/50 S	3.25 (.128)	2.67 (.105)
R282 235 009	2/50 S + D - 2.6/50 S - 2.6/75 S	4.5 (.177)	1.73 (.068)
R282 235 011	5/50 S - 5/50 D	5.41 (.213)	1.73 (.068)
R282 235 013	6/75 S	6.48 (.255)	1.73 (.068)
R282 235 116	10/50 - 11/50 D - 10/75 S	10.54 (.415)	2.54 (.1)



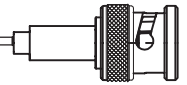

### MATCHING P/N WITH CRIMP TOOLS

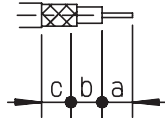

P/N	Assembly	Cable strip dimensions			Center contact			Ferrule*		
		a	b	c	Hex. dim.H	Standard crimp tools P/N	MIL Crimp tool R 282 293 000 + Dies P/N	Hex. dim.H	Standard crimp tools P/N	MIL Crimp tool R 282 293 000 + Dies P/N
R141 072 000	M09	4	2.5	8.5	1.73	R282 223 000	R282 235 013 (M22520/5-13)	6.48	R282 223 000	R282 235 013 (M22520/5-13)
R141 075 000	M05		4.5	10			5.4	R282 235 011 (M22520/5-11)		
R141 082 000	M07		2.5	8.5			6.48	R282 235 013 (M22520/5-13)		
R141 083 000			2.5	8.5			5.4	R282 235 011 (M22520/5-11)		
R141 182 000 R141 183 000	M05		4.5	10			5.4	R282 235 011 (M22520/5-11)		
R141 217 000	M07		2.5	8.5			2.67	R282 235 003 (M22520/5-03)		
R141 220 000 R141 237 000	M07		2.5	8.5			5.4	R282 235 011 (M22520/5-11)		
R141 285 000	M13	4.5	6.5	5.5			R282 235 011 (M22520/5-11)	R282 211 000	R282 235 003 (M22520/5-03)	
R141 292 000	M07	2.5	8.5	5.4			R282 223 000	R282 235 011 (M22520/5-11)		
R141 301 000	M05	4.5	10	6.48				R282 235 013 (M22520/5-13)		
R141 306 000		2.5	8.5	5.4				R282 235 011 (M22520/5-11)		
R141 308 000	M07	4.5	10	6.48				R282 235 013 (M22520/5-13)		
R141 331 400 R141 331 500	M05	2.5	8.5	5.4				R282 235 011 (M22520/5-11)		
R141 332 500	M07	2.5	8.5	5.4				R282 235 013 (M22520/5-13)		
R142 076 000	M05	4.5	10	6.48				R282 235 011 (M22520/5-11)		
R142 085 000 R142 184 000 R142 095 000	M07	2.5	8.5	6.48				R282 235 013 (M22520/5-13)		
R142 217 000	M05	4.5	10	5.4				R282 235 011 (M22520/5-11)		
R142 242 000	M07	2.5	8.5	6.48				R282 235 013 (M22520/5-13)		
R142 295 000		10.54	R282 231 000	R282 235 116 (Y116 DANIELS)						
R142 331 011	M05	4.5	10	6.48			R282 223 000	R282 235 013 (M22520/5-13)		

\* To crimp the ferrule you can choose :  
 either one standard crimp tool with included dies.  
 or the MIL crimp tool and its separated dies.

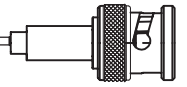

### MATCHING P/N WITH CRIMP TOOLS

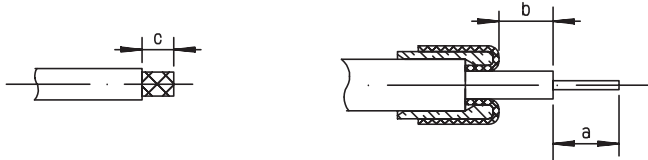

P/N	Assembly	Cable strip dimensions			Center contact			Ferrule*		
		a	b	c	Hex. dim.H	Standard crimp tools P/N	MIL Crimp tool R 282 293 000 Dies P/N	Hex. dim. H	Standard crimp tools P/N	MIL Crimp tool R 282 293 000 Dies P/N
R141 290 200	M12	3	3.5	8.5	1.73	R282 223 000	R282 235 009 (M22520/5-09)	4.5	R282 211 000	R282 235 009 (M22520/5-09)
R141 303 503		4		11			R282 235 011 (M22520/5-11)			
R141 306 503		3	5	10			R282 235 009 (M22520/5-09)			
R142 306 500 R142 306 503							R282 235 011 (M22520/5-11)			
R142 306 520							R282 235 009 (M22520/5-09)			

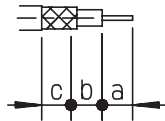

P/N	Assembly	Cable strip dimensions			Center contact	Ferrule*		
		a	b	c	Crimp tool	Hex. dim. H	Standard crimp tools P/N	MIL Crimp tool R 282 293 000 Dies P/N
R141 297 000	M08	9	14	9	R282 291 000 + Positioner R282 997 000 selection n°7	5.4	R282 223 000	R282 235 011 (M22520/5-11)
R142 083 000	M07	4	2.5	8.5	R282 281 000 + Positioner R282 968 000 selection n°7			

\* To crimp the ferrule you can choose :  
 either one standard crimp tool with included dies.  
 or the MIL crimp tool and its separated dies.



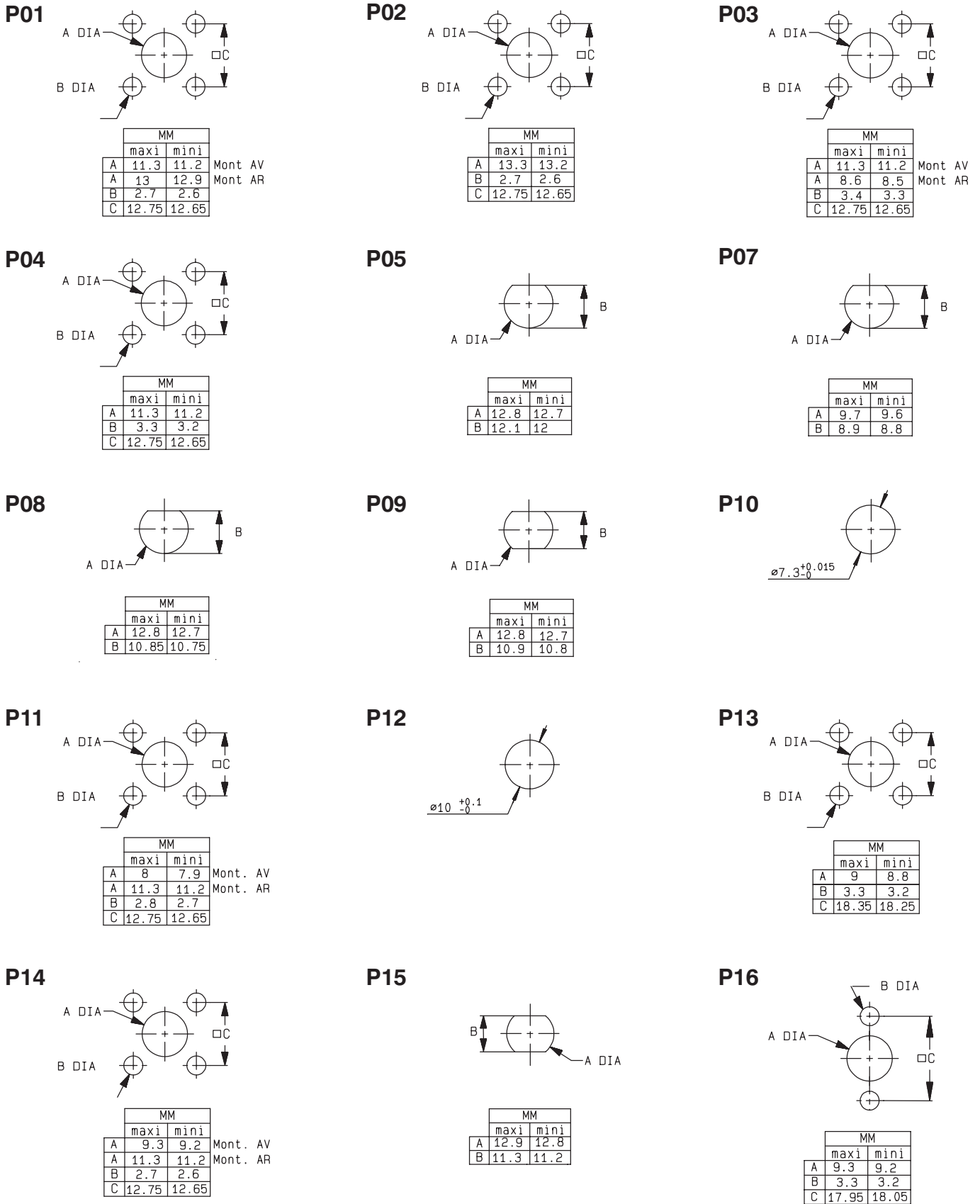
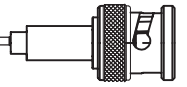

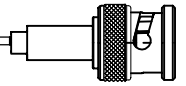

**P17**

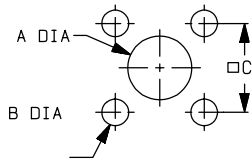

MM		
	maxi	mini
A	7.9	7.8
B	2.7	2.6
C	12.75	12.65

**P18**

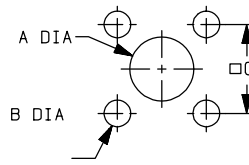

MM		
	maxi	mini
A	8.3	8.2
B	3.4	3.3
C	13.55	13.45

**P19**

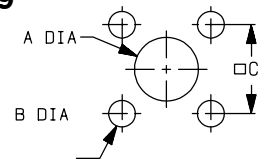

MM		
	maxi	mini
A	8.3	8.2
B	2.7	2.6
C	12.75	12.65

**P20**

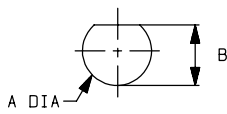

MM		
	maxi	mini
A	11.25	11.15
B	10.43	10.35

**P21**

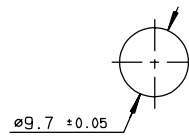

**P22**

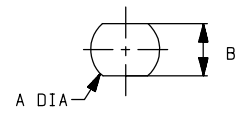

MM		
	maxi	mini
A	9.75	9.65
B	8.65	8.55

**P23**

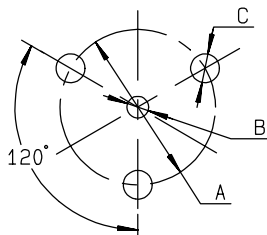

MM		
	maxi	mini
A	8.65	8.55
B	1.3	1.1
C	1.7	1.5

**P24**

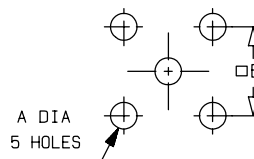

MM		
	maxi	mini
A	1.4	1.2
B	10.21	10.11

**P25**

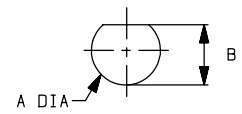

MM		
	maxi	mini
A	12.9	12.8
B	12.15	12.05

**P26**

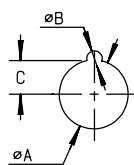

MM		
	maxi	mini
A	16.35	16.25
B	2.43	2.38
C	7.97	7.87

**P27**

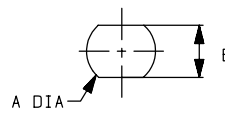

MM		
	maxi	mini
A	15.9	15.8
B	13.6	13.5

**P29**

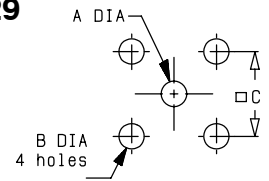

MM		
	maxi	mini
A	1.4	1.3
B	2.1	2.2
C	6.65	6.55

**P30**

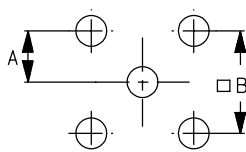

MM		
	maxi	mini
A	3.835	3.785
B	7.67	7.57

**P31**

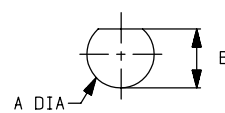

MM		
	maxi	mini
A	12.9	12.8
B	12.15	12

**P32**

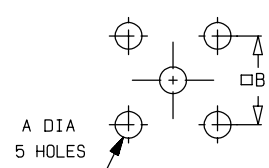

MM		
	maxi	mini
A	5.105	5.055
B	10.21	10.11

### M 01

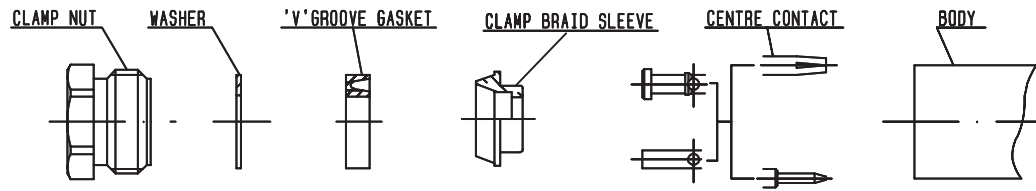

P/N	STRIPPING DIM.			RECOMMENDED COUPLING TORQUE
	a	b	c	
R141 009 000 R141 010 000	4.5	2.5	8.5	450 N.cm
R141 013 000	5.5	0.5	6	
R142 016 000	2.5	3	7	
R141 018 000 R142 018 000	3	1	9	
R141 156 000 R142 157 000	2.5	3	7	
R141 207 000	3	1	9	
R141 208 000 R141 258 000 R141 259 000 R142 268 000 R141 327 000 R142 329 000	2.5	3	7	

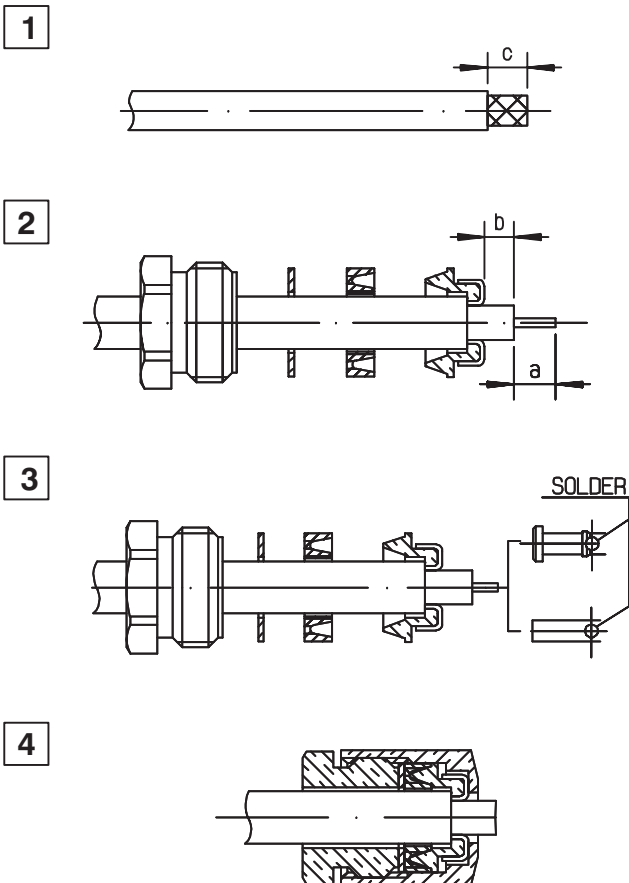

1.1 Strip the cable .

- 2.1 Slide the clamp nut , the washer and the 'V'groove gasket onto the cable .
- 2.2 Slide clamp braid sleeve over braid .
- 2.3 Fold back braid and trim off excess braid .
- 2.4 Trim back dielectric as shown .

3.1 Solder the cable inner conductor into centre contact .

4.1 Screw sub-assembly into the connector body .

### M 02

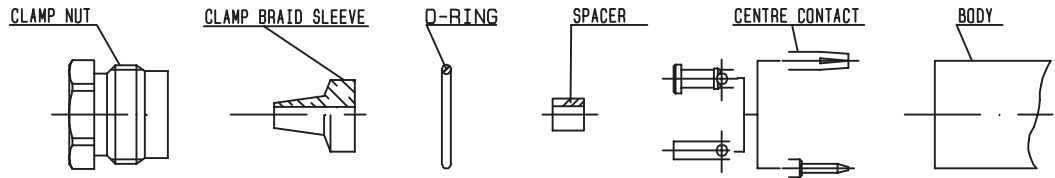

P/N			RECOMMENDED COUPLING TORQUE
R141 003 000	R141 253 000	R141 304 000	450 N.cm
R141 004 000	R141 254 000	R141 323 000	
R141 153 000	R141 277 000	R141 324 000	
R141 154 000	R141 278 000	R142 154 000	

1

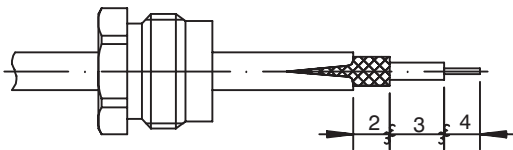

- 1.1 Slide clamp nut onto cable .
- 1.2 Strip the cable .
- 1.3 Cut the jacket ( 2 slots )  
apart if necessary .

2

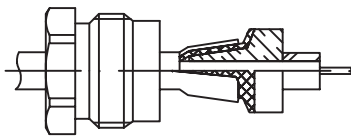

- 2.1 Slide the clamp braid sleeve between  
cable dielectric and braid .
- 2.2 Cut the braid flush with the clamp  
braid sleeve .
- 2.3 Slide the spacer .

3

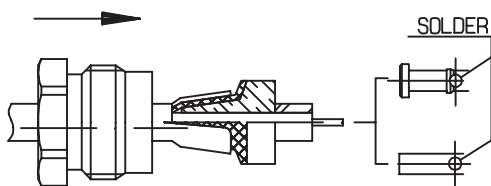

- 3.1 Solder the cable inner conductor into  
centre contact .
- 3.2 Slide the back nut over the clamp  
assembly .

4

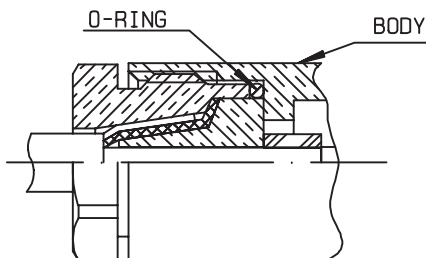

- 4.1 Mount the gasket into the connector .
- 4.2 Screw sub-assembly into the connector  
body .

### M 03

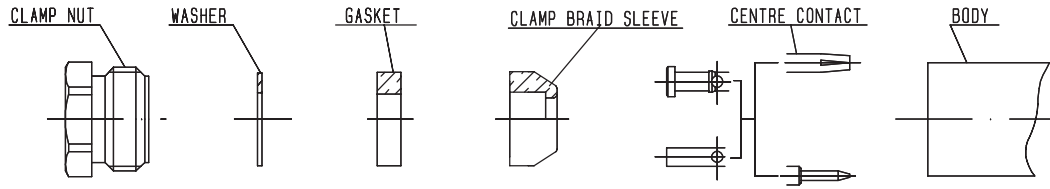

P/N	STRIPPING DIM.			RECOMMENDED COUPLING TORQUE
	a	b	c	
R141 256 000	2.5	3	7	450 N.cm
R142 017 000	3	3.5	10	

1

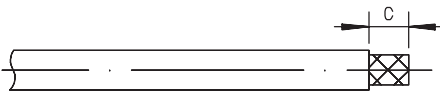

1.1 Strip the cable .

2

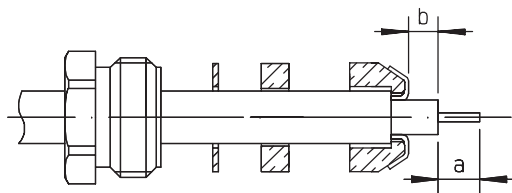

2.1 Slide the clamp nut , the washer and the gasket onto the cable .

2.2 Slide clamp braid sleeve over braid . Fold back braid and trim off excess braid .

2.3 Trim back dielectric as shown .

3

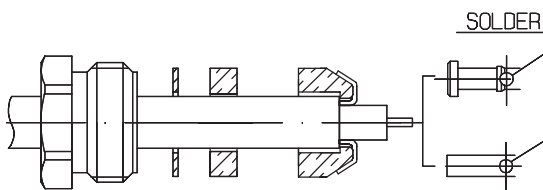

3.1 Solder the cable inner conductor into centre contact .

4

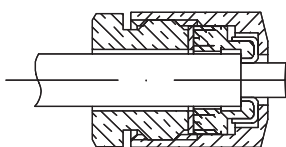

4.1 Screw sub-assembly into the connector body .

### M 04

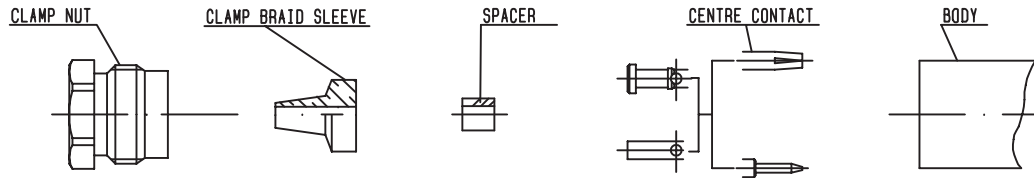

P/N	STRIPPING DIM.			RECOMMENDED COUPLING TORQUE
	a	b	c	
R142 004 000	4	3	2	40 N.cm
R142 202 000	3.5	3.5	1	

1

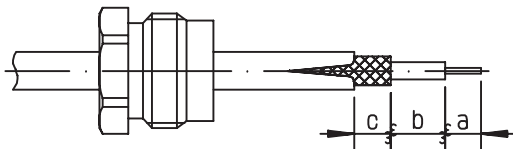

- 1.1 Slide clamp nut onto cable .
- 1.2 Strip the cable .
- 1.3 Cut the jacket ( 2 slots )  
apart if necessary .

2

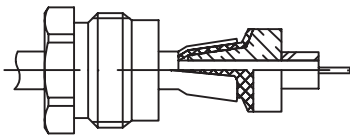

- 2.1 Slide the clamp braid sleeve between  
cable dielectric and braid .
- 2.2 Cut the braid flush with the clamp  
braid sleeve .
- 2.3 Slide the spacer .

3

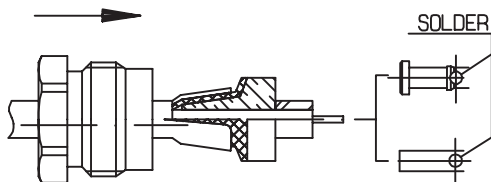

- 3.1 Solder the cable inner conductor into  
centre contact .
- 3.2 Slide the back nut over the clamp  
assembly .

4

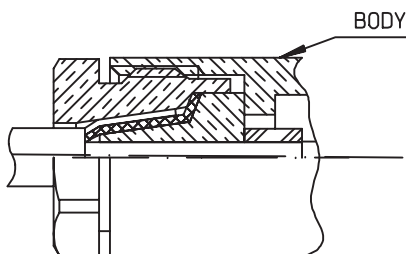

- 4.1 Mount the gasket into the connector .
- 4.2 Screw sub-assembly into the connector  
body .



### M 05

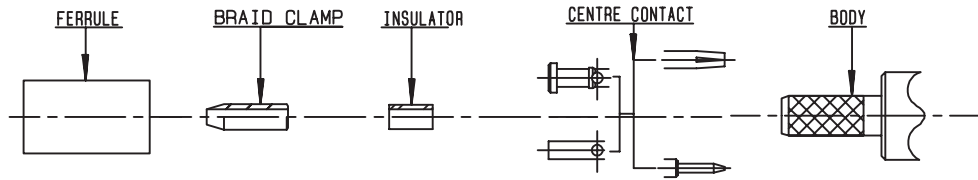

P/N	HEX. DIM.	FERRULE		CENTER CONTACT	
		STANDARD CRIMP-TOOLS DIES INCLUDED	MIL STANDARD R282 293 000 (M22520/5-01)+DIES	STANDARD CRIMP TOOLS DIES INCLUDED	MIL STANDARD R282 293 000 (M22520/5-01)+DIES
R141 075 000 R142 076 000 R141 217 000 R142 217 000 R141 301 000	1,73 - 5,4	R282 223 000	R282 235 011 (M22520/5-11)	R282 223 000	R282 235 011 (M22520/5-11)
R141 306 000 R141 331 400 R141 331 500 R142 331 011	1,73 - 6,48				R282 235 013 (M22520/5-13)

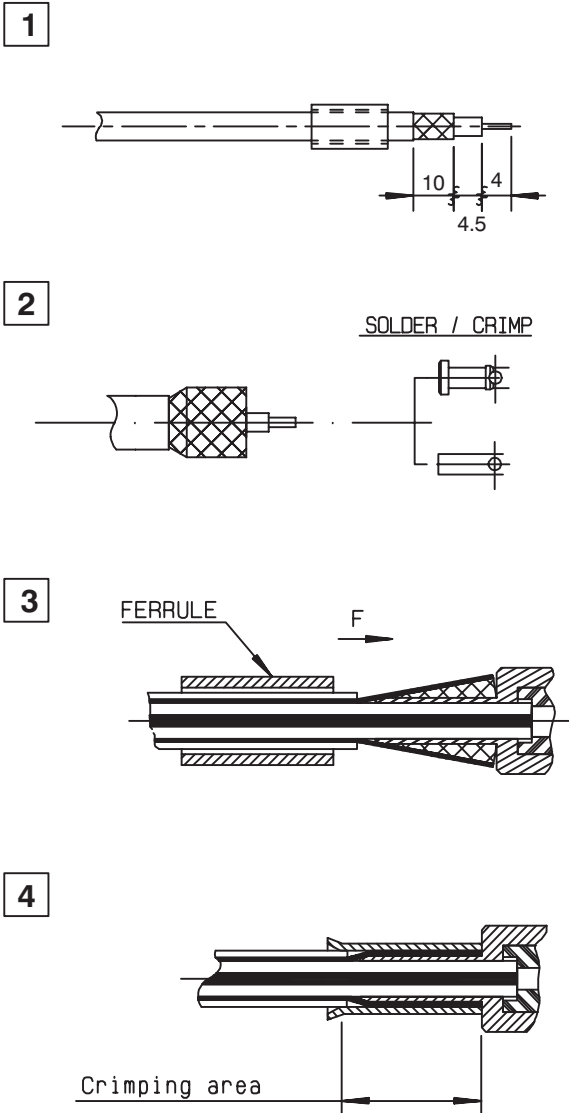

- 1.1 Slide onto the cable the ferrule
- 1.2 Strip the cable .

- 2.1 Fan the braid.
- 2.2 Slide the braid clamp and insulator between the dielectric and the braid.
- 2.3 Slide on centre contact until it bottoms against cable dielectrique . Solder or crimp.

- 3.1 Slide cable into the body until bottoms against insulator .
- 3.2 Slide ferrule over the braid . (In direction F)

- 4.1 Crimp the ferrule.
- 4.2 Cut the excess of braid .

## M 07

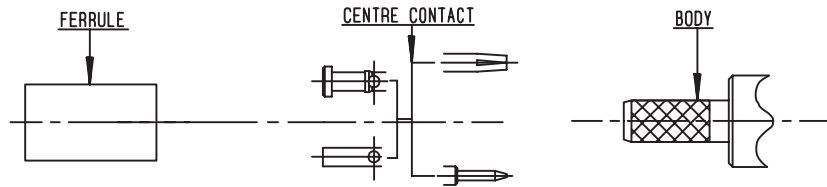

P/N	HEX. DIM. H	FERRULE		CENTER CONTACT		
		DIES INCLUDED	MIL STANDARD R282 293 000 (M22520/5-01)+DIES	DIES INCLUDED	MIL STANDARD R282 293 000 (M22520/5-01)+DIES	
R141 082 000 R141 083 000 R141 182 000 R141 183 000	1,73-5,4	R282 223 000	R282 235 011 (M22520/5-11)	R282 223 000	R282 235 011 (M22520/5-11)	
R142 184 000	1,73-6,48		R282 235 013 (M22520/5-13)		R282 235 013 (M22520/5-13)	
R141 220 000 R141 237 000			R282 235 011 (M22520/5-11)		R282 235 011 (M22520/5-11)	
R142 242 000			R282 235 013 (M22520/5-13)		R282 235 013 (M22520/5-13)	
R141 292 000	1,73-5,4		R282 235 011 (M22520/5-11)		R282 235 011 (M22520/5-11)	
R142 295 000	1,79-10,54				R282 231 000	R282 235 116 (Y116 DANIELS)
R141 308 000 R141 332 500	1,73-5,4		R282 235 013 (M22520/5-13)		R282 235 011 (M22520/5-11)	
R142 085 000	1,73-6,48				R282 235 013 (M22520/5-13)	R282 235 013 (M22520/5-13)
R142 095 000					R282 235 011 (M22520/5-11)	R282 235 011 (M22520/5-11)
R142 083 000	5.4		R282 223 000		R282 235 011 (M22520/5-11)	<b>CRIMP TOOL R282 281 000 + POSITIONER R282 968 000</b> Selection N° 8

1

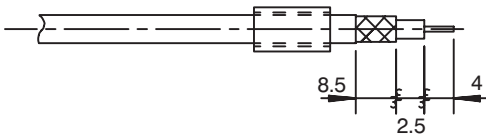

- 1.1 Slide onto the cable the ferrule
- 1.2 Strip the cable .

2

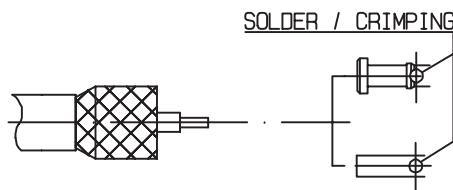

- 2.1 Fan the braid.
- 2.2 Slide on centre contact until it bottoms against cable dielectrique .
- 2.3 Crimp or solder the centre contact .

### M 07 (flg)

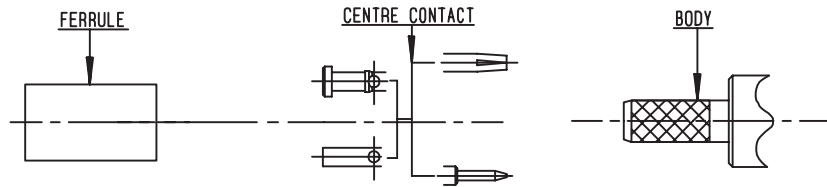

P/N	HEX. DIM. H	FERRULE		CENTER CONTACT	
		DIES INCLUDED	MIL STANDARD R282 293 000 (M22520/5-01)+DIES	DIES INCLUDED	MIL STANDARD R282 293 000 (M22520/5-01)+DIES
R141 082 000 R141 083 000 R141 182 000 R141 183 000	1,73-5,4	R282 223 000	R282 235 011 (M22520/5-11)	R282 223 000	R282 235 011 (M22520/5-11)
R142 184 000	1,73-6,48		R282 235 013 (M22520/5-13)		R282 235 013 (M22520/5-13)
R141 220 000 R141 237 000			R282 235 011 (M22520/5-11)		R282 235 011 (M22520/5-11)
R142 242 000			R282 235 013 (M22520/5-13)		R282 235 013 (M22520/5-13)
R141 292 000			1,73-5,4		R282 235 011 (M22520/5-11)
R142 295 000	1,79-10,54		R282 231 000		R282 235 116 (Y116 DANIELS)
R141 308 000 R141 332 500	1,73-5,4		R282 223 000		R282 235 011 (M22520/5-11)
R142 085 000	1,73-6,48		R282 235 013 (M22520/5-13)		R282 235 013 (M22520/5-13)
R142 095 000					R282 235 011 (M22520/5-11)
R142 083 000	5.4		R282 223 000		R282 235 011 (M22520/5-11)

3

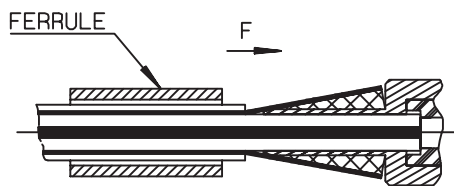

- 3.1 Slide cable into the body until bottoms against insulator .
- 3.2 Slide ferrule over the braid .  
(In direction F)

4

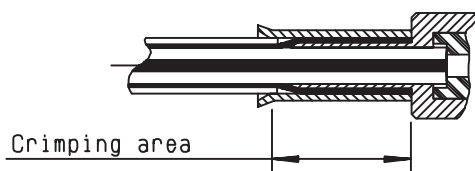

- 4.1 Crimp the ferrule.
- 4.2 Cut the excess of braid .

### M 08

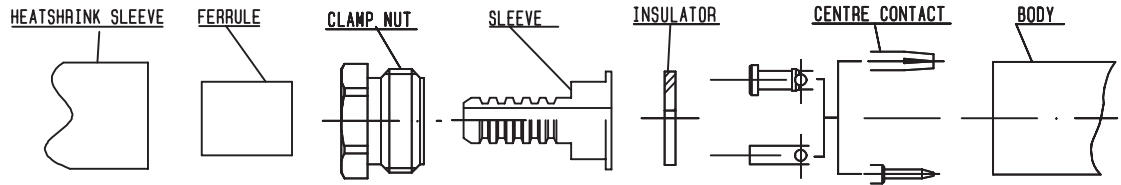

P/N	HEX. DIM. H	DIES INCLUDED	CRIMP TOOLS	CENTER CONTACT	RECOMMENDED COUPLING TORQUE
			MIL STANDARD R282 293 000 (M22520/5-01)+DIES	CRIMP TOOL R282 291 000 + POSITIONER R282 997 000	
R141 297 000	5.4	R282 223 000	R282 235 011 (M22520/5-11)	Selection N° 7	170 N.cm

1

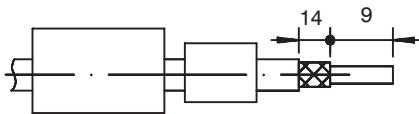

- 1.1 Slide onto cable the ferrule and the heatshrink sleeve.
- 1.2 Strip the cable

2

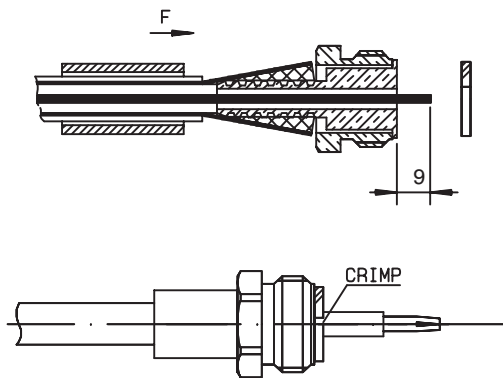

- 2.1 Fan the braid
- 2.2 Slide the sleeve over the clamp nut
- 2.3 Slide the braid on the sub assembly.
- 2.4 Crimp the ferrule.
- 2.5 Cut the excess of braid
- 2.6 Mount the insulator against the sleeve.
- 2.7 Mount center contact against the insulator.
- 2.8 Crimp the center contact

3

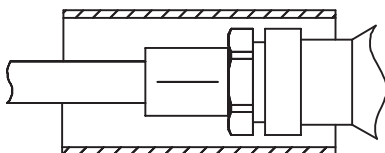

- 3.1 Mount the sub-assembly into the main body and screw the clamp nut.
- 3.2 Slide sleeve over the ferrule and heatshrink it in place.

### M 09

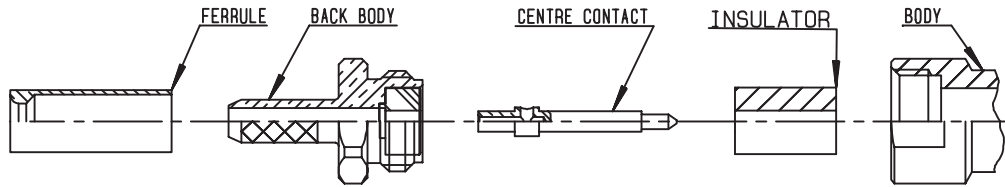

P/N	HEX. DIM. H	FERRULE		CENTER CONTACT		RECOMMENDED COUPLING TORQUE
		STANDARD CRIMP TOOLS DIES INCLUDED	MIL STANDARD R282 293 000 (M22520/5-01)+DIES	STANDARD CRIMP TOOLS DIES INCLUDED	MIL STANDARD R282 293 000 (M22520/5-01)+DIES	
R141 072 000	1,73 - 5,41	R282 223 000	M22520/5-13	R282 223 000	M22520/5-13	450 N.cm

1

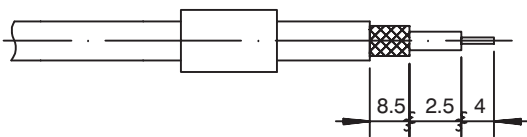

- 1.1 Slide the ferrule onto the cable.
- 1.2 Strip the cable.

2

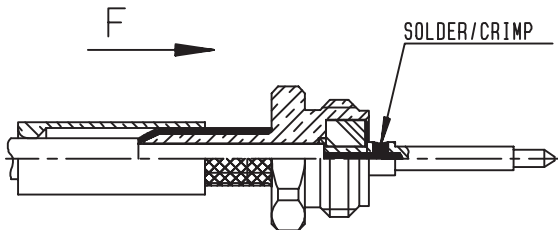

- 2.1 Fan the braid.
- 2.2 Slide the back body between dielectric and braid.
- 2.3 Slide ferrule over the braid. (in direction F)

3

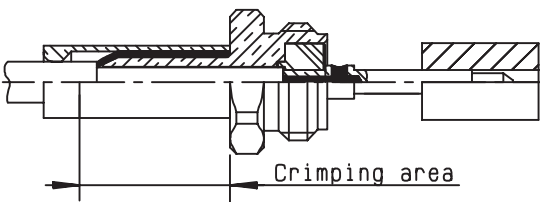

- 3.1 Crimp the ferrule.
- 3.2 Crimp or solder the center contact

4

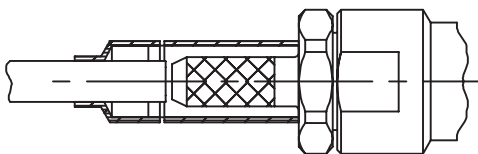

- 4.1 Screw sub-assembly into the connector body.

### M 10

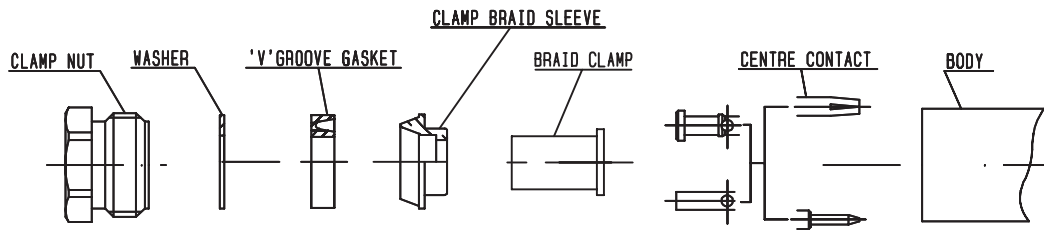

P/N	RECOMMENDED COUPLING TORQUE
R141 052 000 R141 227 000 R141 338 000	400 N.cm

1

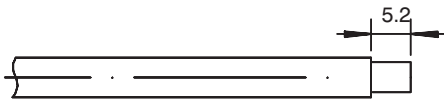

1.1 Strip the cable .

2

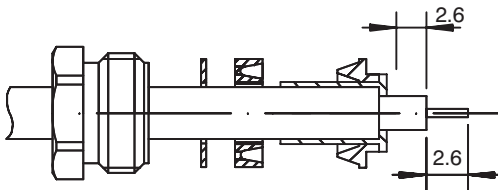

- 2.1 Slide the clamp nut , the washer and the 'V'groove gasket onto the cable .
- 2.2 Slide clamp braid sleeve over braid .
- 2.3 Slide braid clamp over the braid.
- 2.4 Trim back dielectric as shown .

3

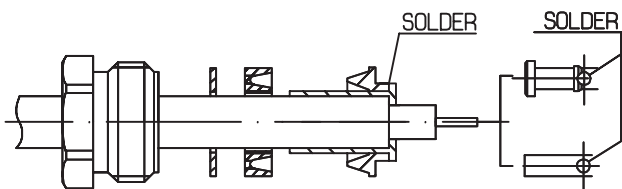

- 3.1 Solder the cable inner conductor into centre contact .
- 3.2 Solder the braid clamp onto the cable.

4

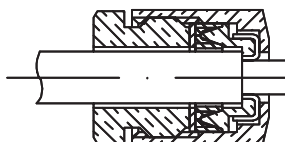

4.1 Screw sub-assembly into the connector body .

## M 12

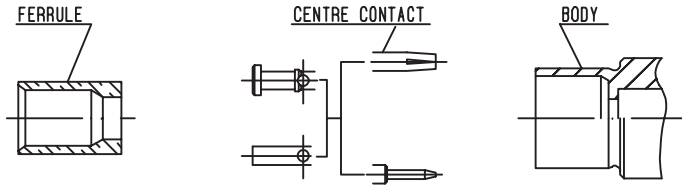

P/N	STRIPPING DIM.			HEX. DIM. H	CRIMP TOOLS		CENTER CONTACT	
	a	b	c		DIES INCLUDED	MIL STANDARD R282 293 000 (M22520/5-01)+DIES	DIES INCLUDED	MIL STANDARD R282 293 000 M22520/5-01)+DIES
R141 290 200	3	3.5	8.5	1,73-4,5	R282 211 000	R282 235 009 (M22520/5-09)	R282 223 000	R282 235 009 (M22520/5-09)
R141 303 503	4	5	11					R282 235 011 (M22520/5-11)
R141 306 503	3	5	10					R282 235 009 (M22520/5-09)
R142 306 500 R142 306 503								R282 235 011 (M22520/5-11)
R142 306 520								R282 235 009 (M22520/5-09)

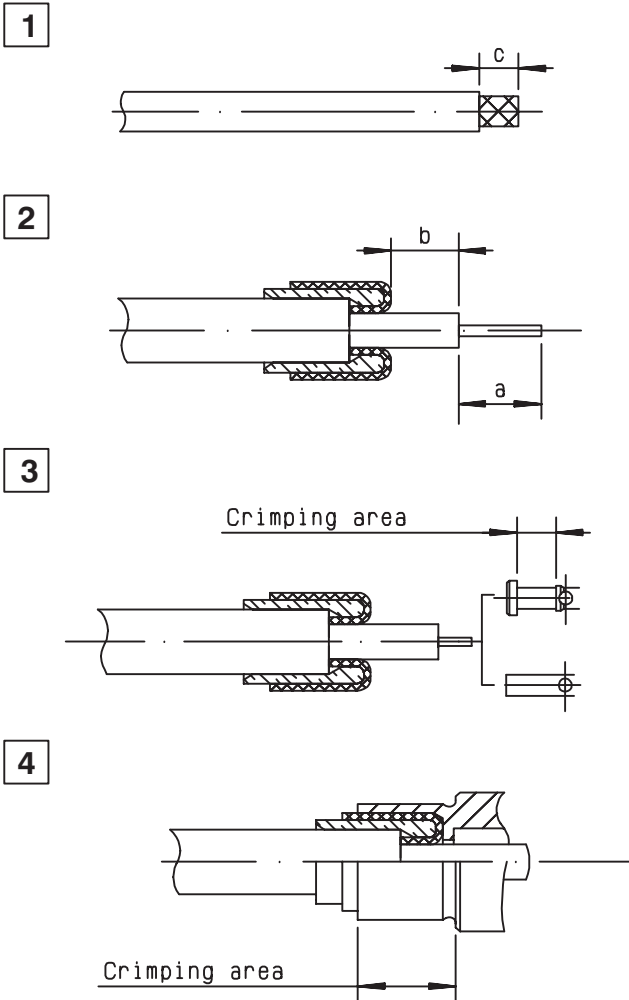

- 1 Strip the cable .
- 2.1 Slide on the ferrule until it bottoms against the jacket .
- 2.2 Fold back braid and trim off surplus braid .
- 2.3 Trim the inner conductor as shown .
- 3.1 Slide on the centre contact until it . bottoms against cable dielectric .
- 3.2 Crimp centre contact.
- 4.1 Slide sub-assembly into the connector body .
- 4.2 Crimp the body.

### M 13

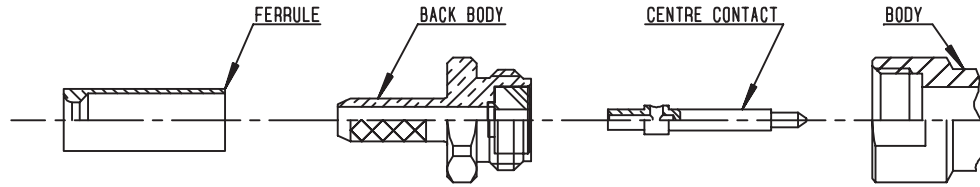

P/N	HEX. DIM. H	CRIMP TOOLS		CENTER CONTACT		RECOMMENDED COUPLING TORQUE
		DIES INCLUDED	MIL STANDARD R282 293 000 (M22520/5-01)+DIES	DIES INCLUDED	MIL STANDARD R282 293 000 (M22520/5-01)+DIES	
R141 285 000	1,73-2,67	R282 211 000	R282 235 003 (M22520/5-03)	R282 223 000	R282 235 011 (M22520/5-11)	90 Ncm

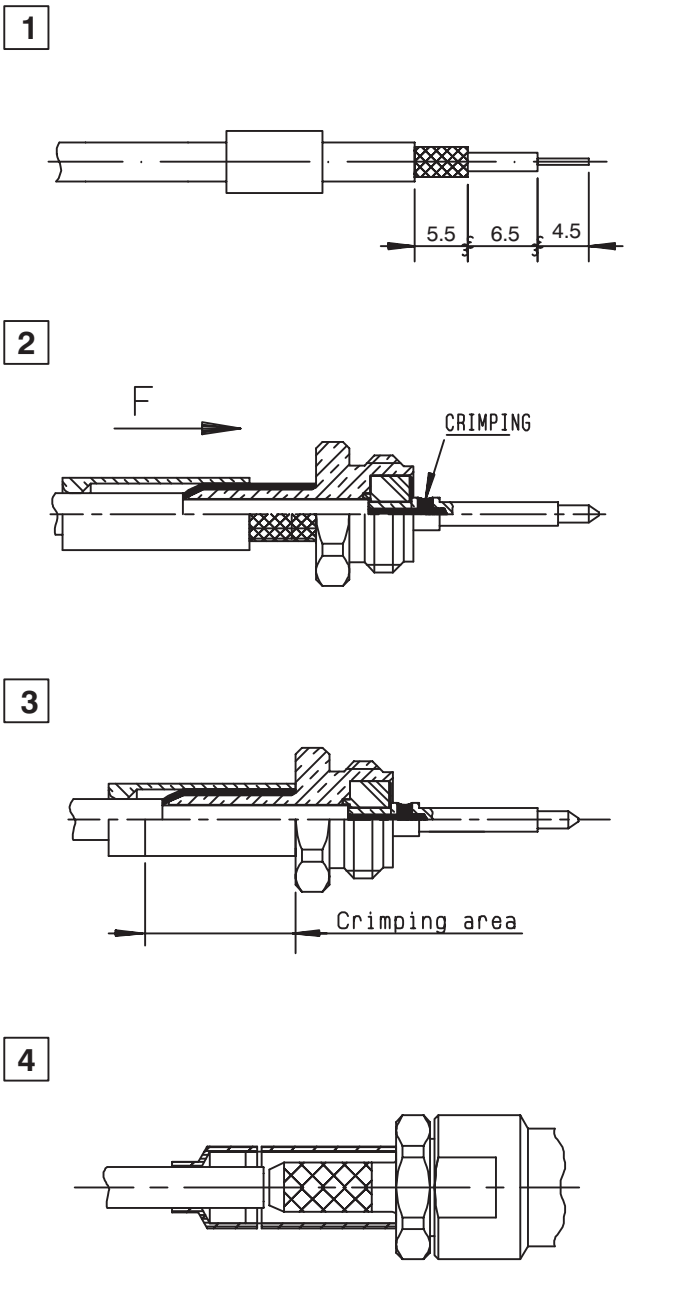

- 1.1 Slide the ferrule onto the cable.
- 1.2 Strip the cable.

- 2.1 Fan the braid.
- 2.2 Slide the back body between dielectric and braid.
- 2.3 Slide ferrule over the braid. (in direction F)

- 3.1 Crimp the ferrule.
- 3.2 Crimp the centre contact

- 4.1 Screw sub-assembly into the connector body.



# M 15

## INSERTION PROCEDURE

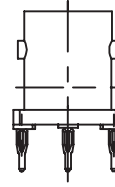

P/N	UPPER TOOL	LOWER TOOL
R141 416 000	R282 878 240	R282 878 524

1

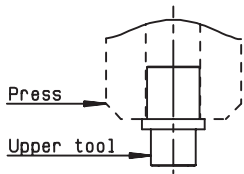

- 1.1 Slide the upper tool (look at upper tool board) into the machine (press) or the flat tool.

2

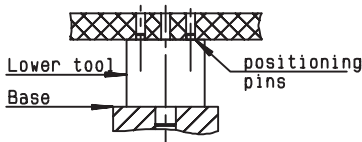

- 2.1 Slide the lower tool into the base and place correctly the PCB on this tool .(positioning pins)

3

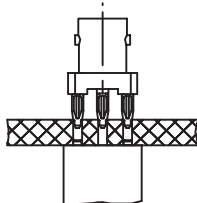

- 3.1 Place correctly the right angle connector with press-fit termination on the PCB and
- 3.2 introduce the press-fit extremity in the holes of the PCB .

4

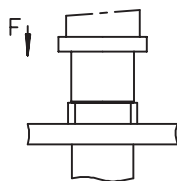

- 4.1 Push on the top (about 500 N) until total insertion .(in direction F)
- 4.2 (Push connector body until it bottoms against PCB) .
- 4.3 Remove the connector and the PCB assembly .

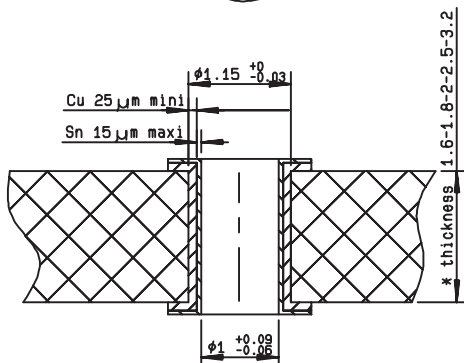

PC BOARD MATERIAL	GLASS FIBRE EPOXYD NEMA:G10,G11,FR4,FR5 DIN 40802 : EP-GC 01 , EP-GC 02
HOLE	FOR 1mm COMPLIANT PIN

## M 15

### EXTRACTION PROCEDURE

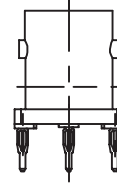

P/N	UPPER TOOL	LOWER TOOL
R141 416 000	R282 878 514	R282 878 534

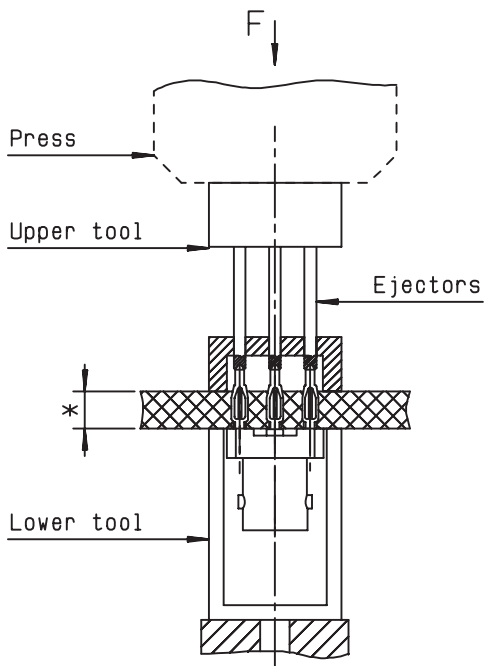
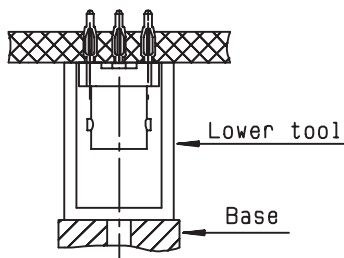

- 1.1 Place correctly the PCB and the connector on lower tool.
  
- 2.1 Place the upper tool at the back of the connector and place correctly the ejectors :
  - on Press-fit pins  
(if PCB thickness < 4.5mm)
  - in the holes of the PCB  
(if PCB thickness > 4.5mm)
  
- 3.1 Press the back of the upper tool to remove the connector ( about 500 N) into the connector slide down onto lower tool .

**CAUTION !**

It's impossible to use a COAXIPRESS a twice .

A plated hole of the PCB can't be used over 3 times .

\* panel thickness: 1.6 to 7 mm

## M 16

### INSERTION PROCEDURE

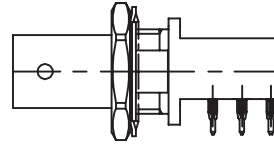

CONNECTORS **R141 684 130**

1

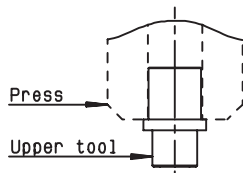

2

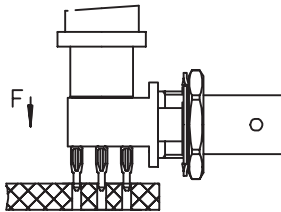

1.1 Slide the flat tool.  
into the machine (press) .

2.1 Push on the top (about 500 N) until  
total insertion .(in direction F)  
(Push connector body until it bottoms  
against PCB) .  
2.2 Remove the connector and the PCB  
assembly .

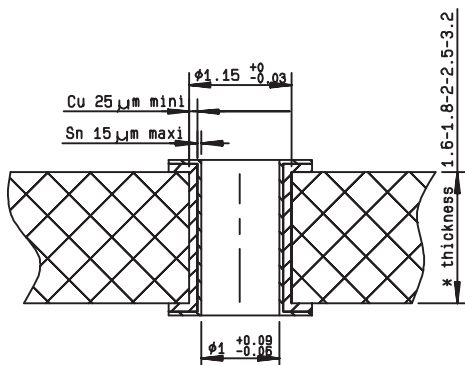

PC BOARD MATERIAL	GLASS FIBRE EPOXYD NEMA:G10,G11,FR4,FR5 DIN 40802 : EP-GC 01 , EP-GC 02
HOLE	FOR 1mm COMPLIANT PIN

### CABLE DIMENSION REFERENCE CHART

The following tables are presented as a convenient reference only. For detailed specifications, refer to the relevant standard or cable manufacturer's specifications. All dimensions are nominal unless otherwise specified.

CABLE	IMP NOM. Ω	DIMENSIONS inch (mm)					CABLE GROUPE inch (mm)/Ω
		CORE		DIELECTRIC	SCREEN DIA. + numb.	JACKET	
		Composition	DIA nom.				

#### FLEXIBLE AND SEMI-RIGID CABLES MIL-C-17-F and LMR CABLES

RG 6A/U	75	single core	.028 (0,72)	.185 (4,70)	.263 (6,70) (D)	.332 (8,43)	.315 (8)/75 D
RG 11A/U	75	7 X 0,40	.047 (1,20)	.285 (7,25)	.340 (8,64) (S)	.405 (10,29)	.394 (10)/75 S
RG 58C/U	50	19 X 0,18	.035 (0,89)	.116 (2,95)	.150 (3,81) (S)	.195 (4,95)	.197 (5)/50 S
RG 59B/U	75	single core	.022 (0,57)	.146 (3,71)	.191 (4,85) (S)	.242 (6,15)	.236 (6)/75 S
RG 62B/U	93	single core	.025 (0,64)	.146 (3,71)	.191 (4,85) (S)	.242 (6,15)	.236 (6)/93 S
RG 71B/U	93	single core	.025 (0,64)	.146 (3,71)	.208 (5,28) (D)	.245 (6,22)	.236 (6)/93 D
RG 141A/U	50	single core	.039 (0,99)	.116 (2,95)	.146 (3,71) (S)	.190 (4,83)	.197 (5)/50 S
RG 142B/U	50	single core	.037 (0,94)	.116 (2,95)	.171 (4,34) (D)	.195 (4,95)	.197 (5)/50 D
RG 174A/U	50	7 X 0,16	.019 (0,48)	.060 (1,52)	.088 (2,24) (S)	.110 (2,79)	.102 (2,6)/50 S
RG 178B/U	50	7 X 0,10	.012 (0,30)	.033 (0,84)	.054 (1,37) (S)	.071 (1,80)	.079 (2)/50 S
RG 179B/U	75	7 X 0,10	.012 (0,30)	.063 (1,60)	.083 (2,13) (S)	.010 (2,54)	.102 (2,6)/75 S
RG 188A/U	50	7 X 0,18	.020 (0,51)	.060 (1,52)	.081 (2,06) (S)	.110 (2,79)	.102 (2,6)/50 S
RG 212/U	50	single core	.056 (1,41)	.185 (4,70)	.210 (5,34) (D)	.331 (8,43)	.315 (8)/50 D
RG 213/U	50	7 X 0,75	.089 (2,25)	.285 (7,25)	.340 (8,64) (S)	.405 (10,29)	.394 (10)/50 S
RG 214/U	50	7 X 0,75	.089 (2,25)	.285 (7,25)	.360 (9,14) (D)	.425 (10,80)	.433 (11)/50 D
RG 216/U	75	7 X 0,40	.047 (1,20)	.285 (7,25)	.360 (9,15) (D)	.425 (10,80)	.433 (11)/75 D
RG 217/U	50	single core	.106 (2,69)	.370 (9,40)	.463 (11,76) (D)	.545 (13,84)	.551 (14)/50 D
RG 218/U	50	single core	.195 (4,95)	.680 (17,27)	.760 (19,30) (S)	.870 (22,10)	.866 (22)/50 S
RG 316/U	50	7 x 0,17	.020 (0,51)	.060 (1,52)	.081 (2,06) (S)	.098 (2,49)	.102 (2,6)/50 S
RD 316	50	7 x 0,17	.020 (0,51)	.060 (1,52)	.087 (2,22) (D)	.110 (2,80)	.102 (2,6)/50 D
RG 400	50	19 x 0,2	.039 (1)	.116 (2,95)	.169 (4,30) (D)	.197 (5)	.197 (5)/50 D
RG 393	50	7 x 0,8	.094 (2,4)	.285 (7,25)	.346 (8,80) (D)	.390 (9,9)	.394 (10)/50 D
RG 401/U	50	single core	.064 (1,63)	.209 (5,31)	--	.250 (6,35)	.250"
RG 402/U	50	single core	.036 (0,92)	.117 (2,98)	--	.141 (3,58)	.141"
RG 405/U	50	single core	.020 (0,51)	.062 (1,68)	--	.087 (2,20)	.085"
LMR 200	50	single core	.044 (1,12)	.116 (2,95)	.144 (3,66) (S)	.197 (5)	.197 (5)/50 S
LMR 400	50	single core	.109 (2,77)	.285 (7,24)	.320 (8,13) (S)	.405 (10,3)	.405 (10,3)/50 S
LMR 600	50	single core	.176 (4,47)	.455 (11,56)	.490 (12,45) (S)	.591 (15)	.591 (15,2)/50 S

#### FLEXIBLE CABLES NF-C 93-550 / SEMI-RIGID CABLES NF-C 93-551

KX 3B	50	7 X 0,16	.019 (0,48)	.059 (1,50)	.088 (2,23) (S)	.10 (2,54)	.102 (2,6)/50 S
KX 4	50	7 X 0,75	.089 (2,25)	.285 (7,25)	.340 (8,64) (S)	.405 (10,29)	.394 (10)/50 S
KX 6A	75	7 X 0,20	.024 (0,60)	.146 (3,70)	.191 (4,85) (S)	.240 (6,10)	.236 (6)/75 S
KX 8	75	7 X 0,40	.047 (1,20)	.285 (7,25)	.340 (8,64) (S)	.405 (10,29)	.394 (10)/75 S
KX 13	50	7 X 0,75	.089 (2,25)	.285 (7,25)	.360 (9,14) (D)	.425 (10,80)	.433 (11)/50 D
KX 14	50	single core	.197 (5,00)	.681 (17,30)	.760 (19,30) (S)	.870 (22,10)	.866 (22)/50 S
KX 15	50	19 X 0,18	.035 (0,89)	.116 (2,95)	.150 (3,81) (S)	.195 (4,95)	.197 (5)/50 S
KX 21A	50	7 X 0,10	.012 (0,30)	.034 (0,87)	.054 (1,37) (S)	.071 (1,80)	.079 (2)/50 S
KX 22A	50	7 X 0,18	.020 (0,51)	.059 (1,50)	.081 (2,06) (S)	.098 (2,50)	.102 (2,6)/50 S
KX 22D	50	7 X 0,17	.020 (0,51)	.059 (1,50)	.098 (2,50) (D)	.118 (3,00)	.102 (2,6)/50 D
KX 23	50	7 X 0,34	.040 (1,02)	.116 (2,95)	.171 (4,34) (D)	.200 (5,10)	.197 (5)/50 D
KX 24	50	7 X 0,80	.094 (2,40)	.285 (7,25)	.360 (9,14) (D)	.429 (10,90)	.433 (11)/50 D
KX 25	75	7 X 0,23	.028 (0,71)	.146 (3,70)	.176 (4,47) (S)	.232 (5,90)	.236 (6)/75 S
KX 30	93	single core	.025 (0,64)	.146 (3,70)	.191 (4,85) (S)	.242 (6,15)	.236 (6)/93 S
KX 52	75	single core	.025 (0,64)	.146 (3,70)	.185 (4,70) (S)	.240 (6,10)	.236 (6)/75 S
KS 1	50	single core	.020 (0,515)	.066 (1,67)	--	.086 (2,18)	.085"
KS 2	50	single core	.036 (0,915)	.118 (3,00)	--	.140 (3,58)	.141"
KS 3	50	single core	.064 (1,63)	.210 (5,33)	--	.250 (6,35)	.250"

#### CORRUGATED CABLES 50 Ω

HELIAX FSJ1-50A	.075 (1,90)	.185 (4,70)	.252 (6,40)	.291 (7,40)	1/4"/50 spiral
HELIAX FSJ2-50	.110 (2,8)	.275 (7)	.375 (9,50)	.415 (10,50)	3/8"/50 spiral
HELIAX FSJ4-50B	.142 (3,60)	.342 (8,70)	.480 (12,20)	.520 (13,20)	1/2"/50 spiral
HELIAX LDF5-50A	.354 (9)	.929 (23,6)	1.016 (25,8)	1.102 (28)	7/8"/50 annulat.
GEDELEX 3,7/50 CCES - 1/2"	.140 (3,56)	.331 (8,40)	.472 (12,00)	.531 (13,50)	1/2"/50 spiral
GEDELEX 2,3/50 CC - 1/4"	.094 (2,40)	.236 (6,00)	.295 (7,50)	.394 (10,00)	1/4"/50 annulat.
HELIAX LDF4-50A	.189 (4,80)	.457 (11,60)	.551 (14,00)	.630 (16,00)	1/2"/50 annulat.
GEDELEX 4,8/50 CCFP - 1/2"	.189 (4,80)	.468 (11,90)	.543 (13,80)	.650 (16,50)	1/2"/50 annulat.

#### ETHERNET CABLES 50 Ω

ACOME P 1977 A (BULL approval)	.085 (2,17)	.242 (6,15)	.325 (8,26) (D)	.406 (10,30)	Ethernet
BELDEN 9880	.085 (2,17)	.247 (6,27)	.315 (8,00) (D)	.405 (10,28)	Ethernet
FILOTEX 63227	.085 (2,17)	.252 (6,40)	.327 (8,30) (D)	.406 (10,30)	Ethernet
BICC H8 112	.085 (2,17)	.250 (6,35)	.326 (8,29) (D)	.406 (10,30)	Ethernet
PRECINCABLE CY 120	.094 (2,40)	.252 (6,40)	.323 (8,20) (D)	.406 (10,30)	Ethernet
TIMES A A4779	.087 (2,20)	.242 (6,14)	.370 (9,40) (D)	.409 (10,40)	Ethernet

(S) : 1 braid ; (D) : 2 braids

Part numbers	Description	Page
R141 003 000	Straight plug clamp type for 2/50/S+D cable	17
R141 004 000	Straight plug clamp type for 2.6/50/S+D cable	17
R141 007 161	Straight plug clamp type for 5/50 S+D cable	10
R141 009 000	Straight plug clamp type for 5/50/S+D cable	17
R141 010 000	Straight plug clamp type for 5/50/S+D cable	17
R141 018 000	Straight plug clamp type for 10+11/50/S+D cable	17
R141 052 000	Straight plug clamp type for .141" cable	17
R141 072 000	Straight plug crimp type for 5/50/S cable	17
R141 075 000	Straight plug crimp type for 2.6/50/S cable	17
R141 075 161	Straight plug crimp type for 2.6/50/S cable	10
R141 082 000	Straight plug crimp type for 5/50/S cable	17
R141 082 161	Straight plug crimp type for 5/50/S cable	10
R141 083 000	Straight plug crimp type for 5/50/D cable	17
R141 153 000	Right angle plug clamp type for 2/50/S+D cable	18
R141 154 000	Right angle plug clamp type for 2.6/50/S+D cable	18
R141 156 000	Right angle plug clamp type for 5/50/S+D cable	18
R141 181 161	Right angle plug crimp type for 2.6/50/S cable	10
R141 182 000	Right angle plug crimp type for 5/50/S cable	18
R141 182 161	Right angle plug crimp type for 5/50/S cable	10
R141 183 000	Right angle plug crimp type for 5/50/D cable	18
R141 207 000	Straight jack clamp type for 5/50/S+D cable	19
R141 208 000	Straight jack clamp type for 5/50/S+D cable	19
R141 217 000	Straight jack crimp type for 2.6/50/S cable	19
R141 220 000	Straight jack crimp type for 5/50/D cable	19
R141 227 000	Straight jack clamp type for .141" cable	19
R141 237 000	Straight jack crimp type for 5/50/S cable	19
R141 237 161	Straight jack full crimp type for 5/50/S cable	10
R141 253 000	Straight flange jack clamp type for 2/50/S+D cable	20
R141 254 000	Straight flange jack clamp type for 2.6/50/S+D cable	20
R141 256 000	Straight insulated flange jack clamp type for 5/50/S+D cable	20
R141 258 000	Straight flange jack clamp type for 5/50/S+D cable	20
R141 259 000	Straight flange jack clamp type for 5/50/S+D cable	20
R141 277 000	Straight flange jack clamp type for 2.6/50/S+D cable	20
R141 278 000	Straight flange jack clamp type for 2.6/50/S+D cable	20
R141 285 000	Straight flange jack crimp type for 2/50/S cable	20
R141 290 200	Straight flange jack clamp type for 2.6/50/S cable	20
R141 292 000	Straight flange jack clamp type for 5/50/S cable	20
R141 297 000	Straight flange jack clamp type for 5/50/D cable	20
R141 301 000	Straight bulkhead jack crimp type for 2/50/D cable	21
R141 303 503	Straight bulkhead jack crimp type for 2/50/S cable	21
R141 304 000	Straight bulkhead jack clamp type for 2.6/50/S cable	21
R141 306 000	Straight bulkhead jack crimp type for 2.6/50/S cable	21
R141 306 503	Straight bulkhead jack crimp type for 2.6/50/S cable	21
R141 308 000	Straight bulkhead jack crimp type for 5/50/S cable	21
R141 323 000	Straight bulkhead jack clamp type for 2/50/S cable	21
R141 324 000	Straight bulkhead jack clamp type for 2.6/50/S cable	21
R141 327 000	Straight bulkhead jack clamp type for 5/50/S+D cable	21
R141 331 400	Straight bulkhead jack crimp type for 2.6/50/S cable	21
R141 331 500	Straight bulkhead jack crimp type for 2.6/50/S cable	21
R141 332 161	Bulkhead jack full crimp type jack for 5/50/S cable	10
R141 332 500	Straight bulkhead jack crimp type for 5/50/S cable	21
R141 338 000	Straight bulkhead jack clamp type for .141" cable	21

Part numbers	Description	Page
R141 403 000	Straight square flange receptacle	22
R141 403 500	Straight square flange receptacle (flange dimensions of N series)	22
R141 404 000	Straight square flange receptacle	22
R141 406 000	Straight square flange receptacle	22
R141 407 000	Straight square flange receptacle	22
R141 410 000	Straight square insulated flange receptacle	22
R141 416 000	Straight PCB female receptacle with press fit pins	25
R141 426 000	Straight PCB female receptacle with solder pins	25
R141 426 161	Straight female PCB receptacle with solder pins	11
R141 426 165	Straight PCB female receptacle with solder pins	25
R141 439 000	Straight square flange receptacle with auxiliary contact	22
R141 440 000	Straight male square flange receptacle with solder pot	24
R141 453 000	Straight 2 hole flange receptacle	22
R141 500 200	Press mount female receptacle	24
R141 501 120	Press mount female receptacle with solder tag	24
R141 508 200	Straight PCB female receptacle with solder pins	25
R141 554 000	Straight bulkhead female receptacle with solder pot	23
R141 554 161	Straight bulkhead female receptacle	11
R141 557 000	Straight bulkhead female receptacle with solder pot	23
R141 559 000	Straight bulkhead female receptacle with solder pot (solder tag)	23
R141 561 161	Straight bulkhead female receptacle	11
R141 563 161	Straight bulkhead female receptacle	11
R141 572 000	Straight bulkhead insulated female receptacle with solder tag	23
R141 574 000	Straight bulkhead insulated female receptacle with solder tag	23
R141 574 161	Straight insulated bulkhead female receptacle	11
R141 580 000	Straight male bulkhead receptacle with solder pot	24
R141 603 000	Straight bulkhead fully sealed female receptacle (Q200-5 insulator)	23
R141 605 000	Straight bulkhead fully sealed female receptacle	23
R141 625 000	Straight bulkhead hermetically sealed female receptacle	23
R141 653 000	Right angle square flange receptacle	22
R141 654 000	Right angle square flange receptacle	22
R141 665 000	Right angle PCB female receptacle with solder pins	25
R141 665 030	Right angle PCB female receptacle with solder pins	25
R141 665 161	Right angle female PCB receptacle with solder pins	11
R141 676 121	Right angle PCB female rear mount receptacle with solder pins	25
R141 676 423	Right angle PCB female rear mount receptacle (+ washer) with solder pins	25
R141 676 433	Right angle PCB female rear mount receptacle (+ 2 insulated washers) with solder pins	25
R141 680 000	Right angle bulkhead receptacle with solder pot	23
R141 684 130	Right angle PCB female receptacle with press fit pins	25
R141 703 000	Male male in series adapter	26
R141 704 000	Female female in series adapter	26
R141 710 000	Female female square flange in series adapter	26
R141 717 000	Female female square insulated flange in series adapter	26
R141 720 000	Female female bulkhead in series adapter	26
R141 720 161	Straight female / female bulkhead adapter	11
R141 723 000	Female female insulated bulkhead in series adapter	26
R141 723 161	Straight female / female insulated bulkhead adapter	11
R141 730 000	Female female panel sealed bulkhead in series adapter	26
R141 753 000	Female female hermetically sealed bulkhead in series adapter	26
R141 770 000	Male female right angle in series adapter	26
R141 780 000	Male / female - female tee	26



Part numbers	Description	Page
R141 782 000	Female / female - female tee	26
R141 789 000	Female / female - male tee	26
R141 799 000	Male / female - female - female cross	26
R141 802 000	Male cap	27
R141 812 000	Male cap with chain	27
R141 812 010	Male cap with chain	27
R141 842 000	Female cap with chain	27
R141 862 000	Male short circuit cap with chain	27
R142 004 000	Straight plug clamp type for 2.6/75/S cable	29
R142 016 000	Straight plug clamp type for 6/75/S cable	29
R142 016 161	Straight plug clamp type for 6/75/S cable	10
R142 017 000	Straight plug clamp type for 8/75/S+D cable	29
R142 018 000	Straight plug clamp type for 10 + 11/75/S + D cable	29
R142 076 000	Straight plug crimp type for 2.6/75/S cable	29
R142 076 161	Straight plug crimp type for 2.6/75/S cable	10
R142 078 161	Straight plug crimp type for 3.8/93/S cable	10
R142 083 000	Straight plug crimp type for 5/75/D cable	29
R142 085 000	Straight plug crimp type for 6/75/S cable	29
R142 085 161	Straight plug crimp type for 6/75/S cable	10
R142 095 000	Straight plug crimp type for 10/75/S cable	29
R142 154 000	Right angle plug clamp type for 2.6/75/S cable	30
R142 157 000	Right angle plug clamp type for 6/75/S cable	30
R142 184 000	Right angle plug crimp type for 6/75/S cable	30
R142 184 161	Right angle plug crimp type for 6/75/S cable	10
R142 202 000	Straight square flange jack clamp type for 2.6/75/S cable	31
R142 217 000	Straight jack crimp type for 2.6/75/S cable	31
R142 242 000	Straight jack crimp type for 6/75/S cable	31
R142 242 161	Straight jack full crimp type for 6/75/S cable	10
R142 268 000	Straight square flange jack clamp type for 6/75/S cable	31
R142 295 000	Straight square flange jack crimp type for 6/75/S cable	31
R142 295 161	Square flange full crimp type jack for 6/75/S cable	10
R142 306 500	Straight bulkhead jack reverse crimp type for 2.6/75/S cable	32
R142 306 503	Straight bulkhead jack reverse crimp type for 2.6/75/S cable	32
R142 306 520	Straight bulkhead jack reverse crimp type for 2.6/75/S cable	32
R142 329 000	Straight bulkhead jack clamp type for 6/75/S cable	32
R142 331 011	Straight bulkhead panel sealed jack crimp type for 2.6/75/S cable	32
R142 334 161	Bulkhead jack full crimp type jack for 6/75/S cable	10
R142 407 000	Straight square flange female receptacle with solder pot	33
R142 412 000	Straight square flange female receptacle with solder pot	33
R142 426 000	Straight PCB female receptacle with solder pins	34
R142 426 030	Straight PCB female receptacle with solder pins	34
R142 426 261	Straight female PCB receptacle with solder pins	11
R142 562 000	Straight bulkhead female receptacle with solder pot	33
R142 562 290	Straight bulkhead female receptacle with solder pot (2 insulated washers + solder tag)	33
R142 580 000	Straight bulkhead panel sealed male receptacle (solder tag)	33
R142 703 000	Male male in series adapter	34
R142 704 000	Female female in series adapter	34
R142 710 000	Female female square flange in series adapter	34
R142 720 000	Female female bulkhead in series adapter	34
R142 720 161	Straight female / female bulkhead adapter	34
R142 723 000	Female female insulated bulkhead in series adapter	34

Part numbers	Description	Page
R142 770 000	Male female right angle in series adapter	34
R142 780 000	Male / female - female tee	35
R142 782 000	Female / female - female tee	35
R142 789 000	Female / female - male tee	35
R191 013 000	BNC male - PC7 adapter	40
R191 015 000	BNC female - PC7 adapter	40
R191 117 000	BNC male - SMC male adapter	40
R191 120 000	BNC female - SMC male adapter	40
R191 123 000	BNC female - SMC female adapter	40
R191 124 000	BNC bulkhead female hermetically sealed - SMC female adapter	40
R191 209 000	BNC male - SMB male adapter	40
R191 212 000	BNC flange female - SMB male adapter	40
R191 213 000	BNC bulkhead female hermetically sealed - SMB male adapter	40
R191 214 000	BNC male - SMB female adapter	40
R191 215 000	BNC female - SMB female adapter (packaging 100)	40
R191 301 000	BNC male - SMA male adapter	40
R191 301 360	BNC male - SMA male adapter (packaging 100)	40
R191 303 000	BNC female - SMA male adapter	40
R191 303 502	BNC female - SMA male Push on adapter	40
R191 304 502	BNC female - SMA female Push on adapter	40
R191 305 000	BNC male - SMA female adapter	40
R191 307 000	BNC female - SMA female adapter	40
R191 403 000	BNC male - TNC female adapter	40
R191 405 000	BNC female - TNC male adapter	40
R191 405 500	BNC female - TNC male Push on adapter	40
R191 417 000	BNC male - N male adapter	40
R191 417 500	BNC male Push on - N male adapter	40
R191 419 000	BNC male - N female adapter	40
R191 421 000	BNC female - N male adapter	40
R191 421 500	BNC female Push on - N male adapter	40
R191 422 000	BNC bulkhead female hermetically sealed - N female adapter	40
R191 424 000	BNC female - N female flange adapter	40
R191 426 000	BNC flange female - N female adapter	40
R191 429 000	BNC female - C male adapter	40
R191 445 000	BNC male - UHF female adapter	40
R191 447 000	BNC female - UHF male adapter (packaging 100)	40
R191 449 000	BNC female - HN male adapter	40
R191 450 000	BNC male - 2 sockets DIA 2 adapter	40
R191 453 000	BNC male - 2 sockets DIA 4 adapter	40
R191 454 000	BNC male - 1 socket DIA 4 adapter	40
R191 471 000	BNC male - MCX male adapter	40
R191 473 000	BNC male - MCX female adapter	40
R191 475 000	BNC female - MCX male adapter	40
R191 477 000	BNC female - MCX female adapter	40
R192 417 000	BNC male - N male adapter	40
R192 418 000	BNC female - N female adapter	40
R192 419 000	BNC male - N female adapter	40
R192 421 000	BNC female - N male adapter	40
R192 430 000	BNC male - 1.6/5.6 female adapter	40
R192 431 000	BNC male - 1.6/5.6 male adapter	40
R192 432 000	BNC female - 1.6 / 5.6 male adapter	40



Part numbers	Description	Page
R192 473 007	BNC male - MCX female adapter	40
R192 475 007	BNC female - MCX male adapter	40
R192 486 000	BNC female - SMZ type 43 female adapter	40
R192 489 500	BNC female - SMZ type 43 female right angle adapter	40
R280 490 020	Solder tag	38
R280 490 030	Solder tag	38
R280 566 000	Black boots for 2.6 mm cable	39
R280 566 001	Red boots for 2.6 mm cable	39
R280 566 002	Green boots for 2.6 mm cable	39
R280 566 003	Blue boots for 2.6 mm cable	39
R280 566 004	Yellow boots for 2.6 mm cable	39
R280 566 005	Grey boots for 2.6 mm cable	39
R280 566 006	White boots for 2.6 mm cable	39
R280 566 007	Brown boots for 2.6 mm cable	39
R280 566 008	Orange boots for 2.6 mm cable	39
R280 566 009	Violet boots for 2.6 mm cable	39
R280 566 010	Nature boots for 2.6 mm cable	39
R280 570 000	Black boots for 5 mm cable	39
R280 571 000	Red boots for 5 mm cable	39
R280 572 000	Green boots for 5 mm cable	39
R280 573 000	Blue boots for 5 mm cable	39
R280 574 000	Yellow boots for 5 mm cable	39
R280 575 000	Grey boots for 5 mm cable	39
R280 576 000	White boots for 5 mm cable	39
R280 577 000	Brown boots for 5 mm cable	39
R280 578 000	Orange boots for 5 mm cable	39
R280 579 000	Violet boots for 5 mm cable	39
R280 580 000	Nature boots for 5 mm cable	39
R280 590 000	Black boots for 6 mm cable	39
R280 591 000	Red boots for 6 mm cable	39
R280 592 000	Green boots for 6 mm cable	39
R280 593 000	Blue boots for 6 mm cable	39
R280 594 000	Yellow boots for 6 mm cable	39
R280 595 000	Grey boots for 6 mm cable	39
R280 596 000	White boots for 6 mm cable	39
R280 597 000	Brown boots for 6 mm cable	39
R280 598 000	Orange boots for 6 mm cable	39
R280 599 000	Violet boots for 6 mm cable	39
R280 600 000	Nature boots for 6 mm cable	39
R280 637 010	Heatshrink sleeve for 2/50 cable	39
R280 637 020	Heatshrink sleeve for 2.6/50 cable	39
R280 637 030	Heatshrink sleeve for 5/50 cable	39
R280 637 040	Heatshrink sleeve for 10+11/50 cable	39
R280 907 000	Insulated washers	38
R282 102 000	Kit : bending of semi rigid cables	46
R282 211 000	Crimping tool (dies included)	47
R282 223 000	Crimping tool (dies included)	47
R282 231 000	Crimping tool (dies included)	47
R282 235 003	Dies	47
R282 235 011	Dies	47
R282 235 013	Dies	47
R282 293 000	MIL 22520/05-1 crimping tool (dies not included)	47

Part numbers	Description	Page
R282 750 000	Bending tool	46
R282 751 050	Bending gauge .085"	46
R282 751 051	Bending gauge .085"	46
R282 751 070	Bending gauge .141"	46
R282 751 071	Bending gauge .141"	46
R282 751 080	Bending gauge .250"	46
R282 800 000	Soldering device (80 W)	45
R282 800 001	Soldering device (250 W)	45
R282 803 000	Fume extraction device	45
R299 510 000	Cable stripper	12
R299 511 001	Replacement blades for cable stripper	12
R404 011 000	Low power termination 50 ohms, DC - 1 GHz	42
R404 012 000	Low power termination 75 ohms, DC - 1 GHz	42
R404 013 000	Low power termination 50 ohms, DC - 1 GHz	42
R404 014 000	Low power termination 75 ohms, DC - 1 GHz	42
R404 110 000	Low power termination 50 ohms, DC - 8 GHz	42
R404 111 000	Low power termination 50 ohms, DC - 2.5 GHz	42
R404 112 000	Low power termination 50 ohms, DC - 2.5 GHz	42
R404 412 000	Resistive pad 75 ohms	42
R404 441 000	Resistive pad 50 ohms	42
R404 442 000	Resistive pad 75 ohms	42
R404 505 000	Medium power termination 50 ohms, DC - 2 GHz	43
R404 510 000	Medium power termination 50 ohms, DC - 8 GHz	43
R404 555 000	Medium power termination 50 ohms, DC - 2 GHz	43
R404 560 000	Medium power termination 50 ohms, DC - 8 GHz	43
R412 403 000	Low level attenuator, DC - 2 GHz, 3 dB	43
R412 403 124	Low level attenuator, DC - 3 GHz, 3 dB	43
R412 406 000	Low level attenuator, DC - 2 GHz, 6 dB	43
R412 406 124	Low level attenuator, DC - 3 GHz, 6 dB	43
R412 410 000	Low level attenuator, DC - 2 GHz, 10 dB	43
R412 410 124	Low level attenuator, DC - 3 GHz, 10 dB	43
R412 420 000	Low level attenuator, DC - 2 GHz, 20 dB	43
R412 420 124	Low level attenuator, DC - 3 GHz, 20 dB	43
R414 403 000	Low level attenuator, DC - 8 GHz, 3 dB	43
R414 406 000	Low level attenuator, DC - 8 GHz, 6 dB	43
R414 410 000	Low level attenuator, DC - 8 GHz, 10 dB	43
R414 420 000	Low level attenuator, DC - 8 GHz, 20 dB	43
R415 403 000	Medium power attenuator, 3 dB, 15 W	44
R415 406 000	Medium power attenuator, 6 dB, 12 W	44
R415 410 000	Medium power attenuator, 10 dB, 10 W	44
R415 420 000	Medium power attenuator, 20 dB, 10 W	44